



Assembly Instructions

WEEKENDER— WEST COAST FRAME TENTS

10'x10' /	20'x30'
10'x20' /	20'x40'
20'x20' /	20'x60'



WEEKENDER-WEST COAST FRAME TENT OVERVIEW



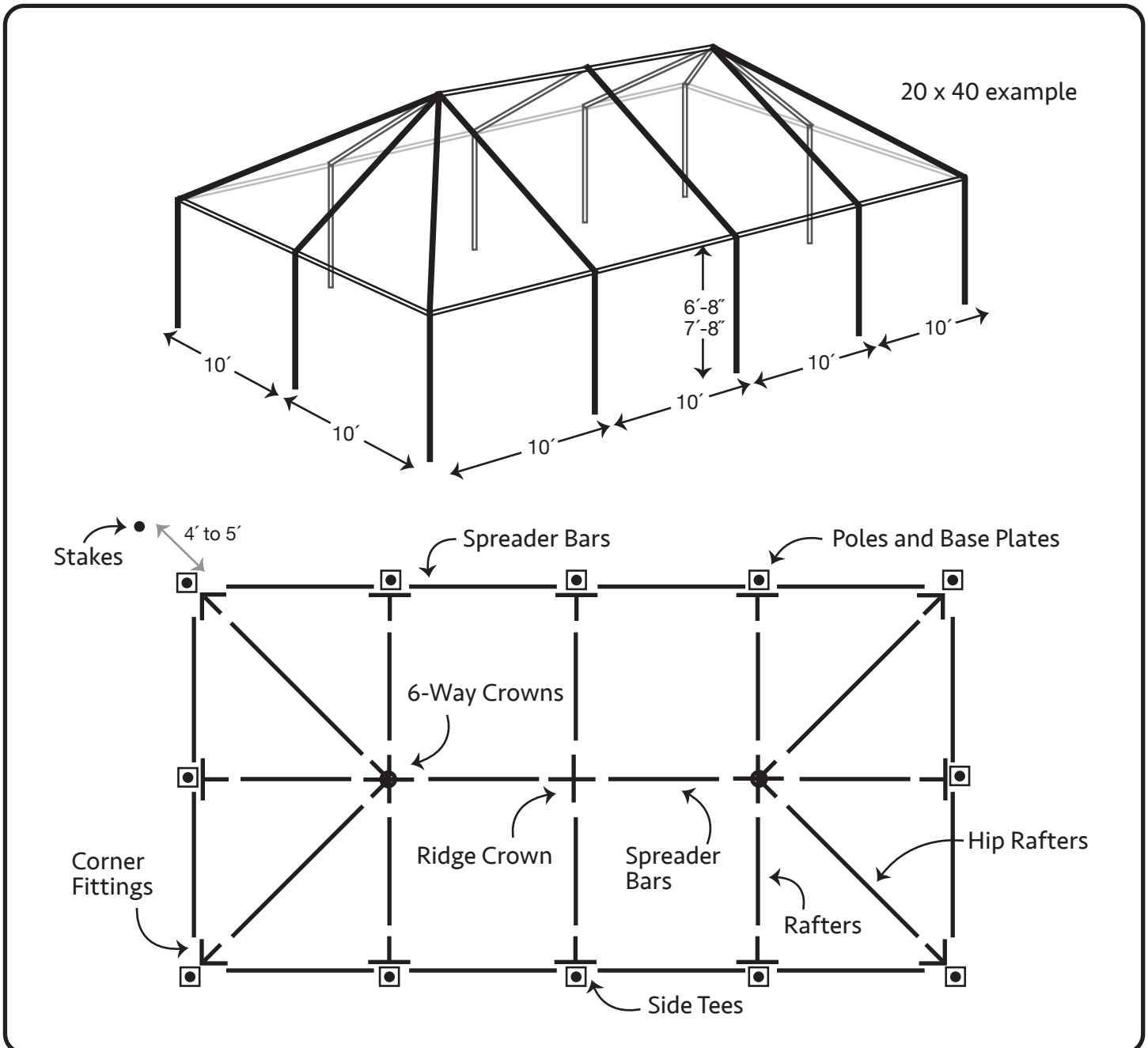

West Coast designed tents involved less frame work, with no center poles. This tent features stronger tubes, fewer parts which makes for faster set-up. It's worth pointing out smaller parts means; less load, easy to assemble, faster set-up and faster strike time. For investment purposes, the frames are expandable. With the purchase of extra parts you can easily make a second, larger tent.

Take a look here at the basic design.







STEP 1. CHECK ITEM LIST







10 x 10 WEEKENDER (WCF)







10'x10' Frame Tent								
CTN NO.	Parts No.	SKU	Item	Length MM	Length FT	QTY	Weight Lbs Each	Net Weight Lbs
1/2	A	BT-FECNR	Corner			4	1.98	7.94
	B	BT-FE4WC	4-Way Crown			1	2.20	2.20
	12	BT-FEBP	Base Plate			4	0.88	3.53
		BT-FEHS1	Hook Stakes	7x300	5/16 x 12in.	8	0.09	0.71
		BT-FEHS2	Hook Stakes	12X500	1/2 x 20in.	4	0.99	3.97
		BT-FE1RS	Ratches Strap	5X3500	11.5	4	0.55	2.20
	M6	BT-FEEB	Fitting Eye Bolt			16	0.03	0.41
	M8	BT-FEBWN	Frame Pipe Bolts			22	0.02	0.49
	M8		Frame Pipe Wing Nuts			22	0.01	0.14
			BT-FE11FB	Oxford Bag Black			1	0.00
2/2	#1	BT-FEP1		1498	4.91	12	3.31	39.68
	#2	BT-FEP2		1410	4.625	4	2.98	11.94
	#9	BT-FEP9		695	2.28	4	1.47	5.88
	#4	BT-FEP4		680	2.23	4	1.44	5.76
			BT-FE11FB	Oxford Bag Black			1	0.00

10 x 20 WEEKENDER (WCF)

10'x20' Frame Tent								
CTN NO.	Parts No.	SKU	Item	Length MM	Length FT	QTY	Weight Lbs Each	Net Weight Lbs
1/2	A	BT-FECNR	Corner			4	1.98	7.94
	C	BT-FE3WC	3-Way Crown			2	2.20	4.41
	D	BT-FE4ST	Side Tee			2	2.20	4.41
	E	BT-FERC	Ridge Crown			1	2.20	2.20
	12	BT-FEBP	Base Plate			6	0.88	5.29
		BT-FEHS1	Hook Stakes	7x300	5/16 x 12in.	12	0.09	1.06
		BT-FEHS2	Hook Stakes	12X500	1/2 x 20in.	6	0.99	5.95
		BT-FE1RS	Ratches Strap	1"X13'	13	6	0.79	4.76
	M6	BT-FEEB	Fitting Eye Bolt			28	0.03	0.88
	M8	BT-FEBWN	Frame Pipe Bolts			32	0.02	0.79
	M8		Frame Pipe Wing Nuts			32	0.01	0.22
		BT-FE12FB	Oxford Bag Black			1	0.00	0.00
2/2	#1	BT-FEP1		1498	4.91	16	3.31	52.91
	#2	BT-FEP2		1410	4.625	8	2.20	17.64
	#9	BT-FEP9		695	2.28	4	1.47	5.88
	#7	BT-FEP7		1570	5.15	2	3.32	6.65
	#4	BT-FEP4		680	2.23	6	1.65	9.92
			BT-FE12FB	Oxford Bag Black			1	0.00



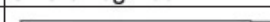



STEP 1. CHECK ITEM LIST (continued)

20 x 20 WEEKENDER (WCF)								
20'x20'Frame Tent								
CTN NO.	Parts No.	SKU	Item	Length MM	Length FT	QTY	Weight Lbs Each	Net Weight Lbs
1/2	A	BT-FECNR	Corner			4	1.98	7.94
	F	BT-FE8WC	8-Way-Crown			1	5.51	5.51
	D	BT-FE4ST	Side Tee			4	2.20	8.82
	12	BT-FEBP	Base Plate			8	0.99	7.94
		BT-FEHS1	Hook Stakes	7x300	5/16 x 12in.	16	0.09	1.41
		BT-FEHS2	Hook Stakes	12X500	1/2 x 20in.	8	0.99	7.94
		BT-FE1RS	Ratches Strap	1"X13'	13	8	0.80	6.39
	M6	BT-FEEB	Fitting Eye Bolt			34	0.00	0.00
	M6	BT-FEBWNCB	Crossbar Bolt			1	0.020	0.02
	M6		Crossbar Wing Nut			1	0.010	0.01
	M8	BT-FEBWN	Frame Pipe Bolts	50		50	0.00	0.00
	M8		Frame Pipe Wing Nuts			50	0.00	0.00
	#3	BT-FEP3		460	1.5	4	2.20	8.82
	#4	BT-FEP4		680	2.23	8	1.65	13.23
	BT-FE22FB	Oxford Bag Black			2	0.00	0.00	
2/2	#2	BT-FEP2		1410	4.625	8	2.98	23.87
	#5	BT-FEP5		1600	5.25	4	3.39	13.55
	#6	BT-FEP6		1435		1	2.98	2.98
	#8	BT-FEP8		1435		1	2.98	2.98
	#1	BT-FEP1		1498	4.91	32	3.31	105.82
		BT-FE22FB	Oxford Bag Black			1	0.00	0.00







20 x 30 WEEKENDER (WCF)								
20'x30'Frame Tent								
CTN NO.	Parts No.	SKU	Item	Length MM	Length FT	QTY	Weight Lbs Each	Net Weight Lbs
1/2	A	BT-FECNR	Corner			4	1.98	7.94
	G	BT-FE6WC	6-Way Crown			2	5.07	10.14
	D	BT-FE4ST	Side Tee			6	2.20	13.23
	12	BT-FEBP	Base Plate			10	0.88	8.82
		BT-FEHS1	Hook Stakes	7x300	5/16 x 12in.	20	0.09	1.76
		BT-FEHS2	Hook Stakes	12X500	1/2 x 20in.	10	0.99	9.92
		BT-FE1RS	Ratches Strap	1"X13'	13	10	0.79	7.94
	M6	BT-FEEB	Fitting Eye Bolt			44	0.00	0.00
	M6	BT-FEBWNCB	Crossbar Bolt			2	0.020	0.04
	M6		Crossbar Wing Nut			2	0.010	0.02
	M8	BT-FEBWN	Frame Pipe Bolt	50		62	0.00	0.00
	M8		Frame Pipe Wing Nut			62	0.00	0.00
	#2	BT-FEP2		1410	4.625	11	2.98	32.83
	#3	BT-FEP3		460	1.5	6	0.97	5.84
	#4	BT-FEP4		680	2.23	10	1.44	14.39
	#6	BT-FEP6		1435		2	2.89	5.78
#8	BT-FEP8		1435		2	2.89	5.78	
	BT-FE23FB	Oxford Bag Black			2	0.00	0.00	
2/2	#1	BT-FEP1		1498	4.91	41	3.17	129.99
	#5	BT-FEP5		1600	5.25	4	3.39	13.55
		BT-FE23FB	Oxford Bag Black			1	0.00	0.00

STEP 1. CHECK ITEM LIST (continued)

20 x 40 WEEKENDER (WCF)

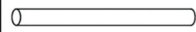
20'x40'Frame Tent								
CTN NO.	Parts No.	SKU	Item	Length MM	Length FT	QTY	Weight Lbs Each	Net Weight Lbs
1/3	A	BT-FECNR	Corner			4	1.98	7.94
	G	BT-FE6WC	6-Way Crown			2	5.07	10.14
	D	BT-FE4ST	Side Tee			8	2.20	17.64
	E	BT-FERC	Right Crown			1	2.20	2.20
	12	BT-FEBP	Base Plate			12	0.88	10.58
		BT-FEHS1	Hook Stakes	7x300	5/16 x 12in.	24	0.09	2.20
		BT-FEHS2	Hook Stakes	12X500	1/2 x 20in.	12	1.01	12.13
		BT-FE1RS	Ratches Strap	1"X13'	13	12	0.79	9.52
	M6	BT-FEEB	Fitting Eye Bolt			52	0.02	1.28
	M6	BT-FEBWNCB	Crossbar Bolt			3	0.020	0.06
	M6		Crossbar Wing Nut			3	0.010	0.03
	M8	BT-FEBWN	Frame Pipe Bolts	50		78	0.02	1.43
	M8		Frame Pipe Wing Nuts			78	0.01	0.40
			BT-FE24FB	Oxford Bag Black			1	0.00
2/3	#1	BT-FEP1		1498	4.91	40	3.31	132.28
			BT-FE24FB	Oxford Bag Black			1	0.00
3/3	#3	BT-FEP3		460	1.5	8	2.20	17.64
	#4	BT-FEP4		680	2.23	12	2.20	26.46
	#2	BT-FEP2		1410	4.625	14	2.98	41.78
	#1	BT-FEP1		1498	4.91	10	3.53	35.27
	#5	BT-FEP5		1600	5.25	4	3.39	13.55
	#6	BT-FEP6		1435		3	2.89	8.66
	#8	BT-FEP8		1435		3	2.89	8.66
			BT-FE24FB	Oxford Bag Black			1	0.00

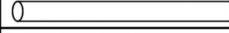
STEP 1. CHECK ITEM LIST (continued)

20 x 60 WEEKENDER (WCF)						
20'x60'Frame Tent						
CTN NO.		Item	Length MM	Length FT	QTY	Weight KGS
1/4	A	Corner			4	3.60
	G	6-Way Crown			2	4.60
	D	Side Tee			12	11.00
	E	Right Crown			3	1.00
	12	Base Plate			16	4.80
		Hook Stakes	7x300		32	1.000
		Hook Stakes	12X500		16	5.500
		Ratches Strap	1''X13'	13	16	4.320
	M6	Eye Bolt			70	0.580
	M6	Wing Bolt			5	Cross Bar
	M6	Nuts			5	Cross Bar
	M8	Bolt	50		110	0.650
	M8	Nuts			110	0.180
		Oxford Bag Black			1	
2/4	#1		1498	4.91	40	55
		Oxford Bag Black			1	
3/4	#1		1498		28	38
	#5		1600	5.25	4	6
	#4		680	2.23	16	10
4/4	#3		460	1.5	12	5
	#2		1410	4.625	20	26
	#6		1435		5	5
	#8		1435		5	5
		Oxford Bag Black			1	

STEP 1. CONTINUED

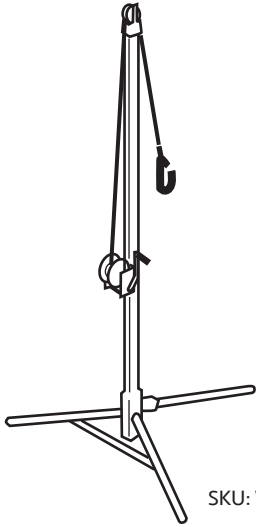

SKU: WCF-JACK-12

This item is very important in the process, Frame Tent Jack (sold separately). Some West Coast Frame tents require *frame tent jacks*—and larger tents require multiple jacks.

General rules are; work on the long side, one side at a time, and never place jack in the middle of a spreader bar. (set-up and use can be found on internet)

Tent Size	Estimated Quantity
10 x 10	none
10 x 20	none
20 x 20	none
20 x 30	2
20 x 40	3

Recommended Tools

6ft. step ladders
Sledge Hammer
Tape Measure

Stake Driver
(for larger tents)

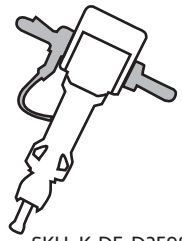

SKU: K-DE-D25980K

WARNING

Tent products are manufactured for use as temporary structure and do not meet structural code, unless specified. Since weather is unpredictable, the customer must incorporate their own good judgment, common sense & knowledge of local conditions with the installation instruction guidelines. The customer is responsible to anticipate weather severity for proper time and method of construction.

‘BEFORE YOU DIG’ (hammer stakes)

By Law you are required to contact your local “Call before you dig” number before you plan to dig. After calling, your local utility company will mark the location of underground utility lines. Laws from state to state vary on how far in advance you must call.

Planning ahead and checking with your state’s program is always a smart idea. Failure to obtain a line location before digging can result in a substantial fine. Please find your local “call before your dig number” by going to call811.com.

STEP 2. SAFETY CHECK LIST



- When building or assembling anything above shoulder height, wear a hard hat
- Steel toe boots are recommended
- Inspect the site, look for overhead and underground obstructions— such as utilities
- Call your local utility to have utility lines marked (call 3–5 days ahead)— call811.com is a good resource— ‘click’ 811 in Your State
- Inspect all ropes and tie lines
- Inspect poles, making sure there are no bends or breaks
- Replace or repair any items in poor condition

STEP 3. LAYOUT FRAME

Position parts in the exact location of finished tent

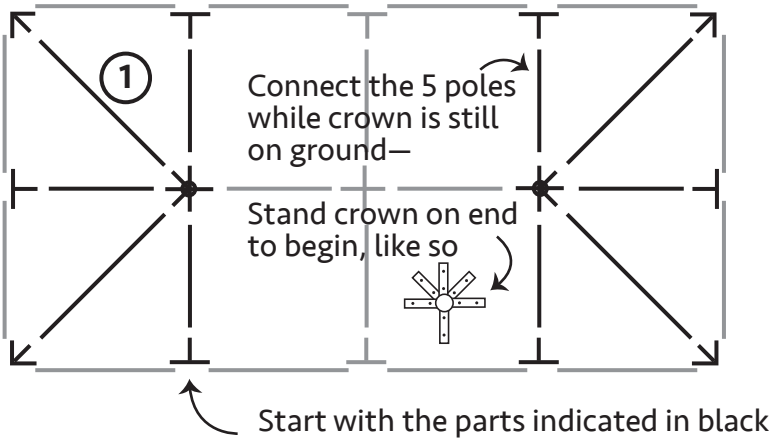

- Place all tent poles and fittings on the ground, in the location you have selected for the finished tent
- This layout illustrates a 20 x 40 tent — see (**appendix**) for your specific size, layout and pole sizes
- Connect and form full length poles, by connecting shorter poles together— (connections will be made using either an eye-screw or nut-bolt, supplied)
- See (**figure A.**) for eye-screw usage

- 1) Start with the crown and its connecting poles—the drawing shows the correct position of the crown—secure these parts using appropriate eye-screw or nut-bolt
- Stand these two end assemblies up, to connect the ridge parts next

FIGURE A. 'EYE-SCREW' VS. 'NUT-BOLT'

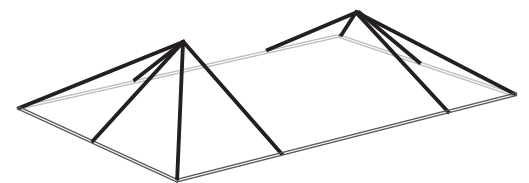
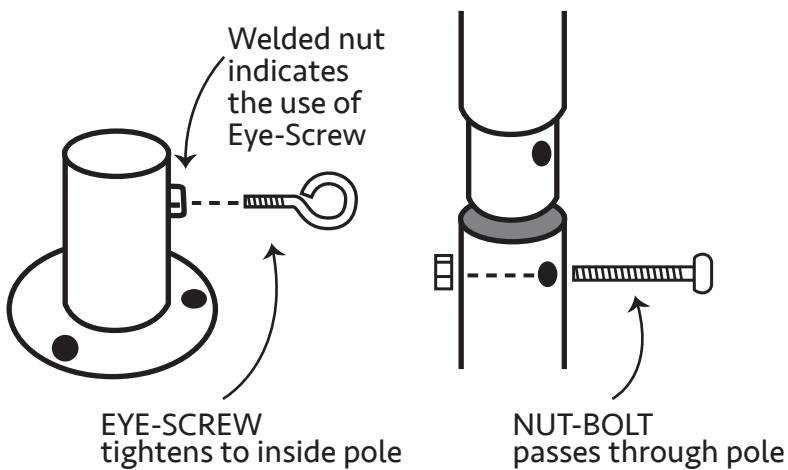

Reminder:
Frame plans and connector positions, for your tent, appear in the appendix

- 2) Connect the ridge line next, crowns and spreaders

- While standing on a ladder(s) make all connections from end to end
- If you are short of people, use a tent jack to hold horizontal poles

- 3) Connect all perimeter bars to the upper spreaders and rafter bars
- When working around the perimeter, the last connection should be at a corner, *not* a side tee

- 4) For sizes; 20x20, 20x30 and 20x40 attach Cross Bar to rafter poles — see (**appendix**)

- 5) Double check all nut-bolt/eye-screws — so they are secure

- The frame should now be complete

STEP 4. RIDGE AND PERIMETER

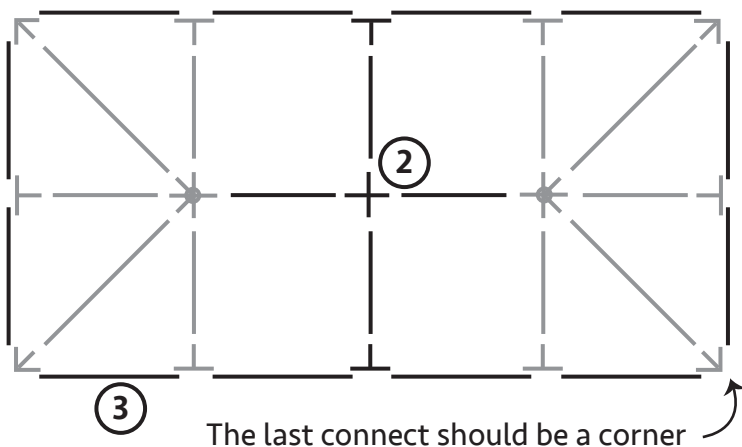

STEP 5. COMPLETED FRAME

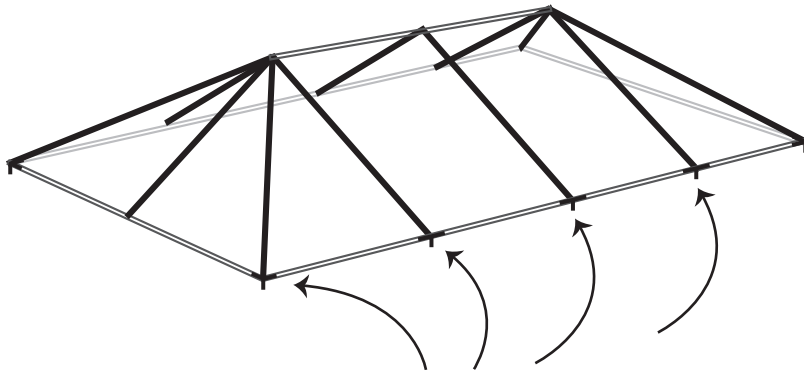

If repositioning is necessary, try to have one person lift at each fitting, all the way around

- Now that the frame portion is complete and while the frame is still on the ground, double check all connections
- Also, with plenty of hands on deck, lift and adjust frame position if needed, at this point
- Always lift at a side or corner fitting

STEP 6. RATCHET STRAPS

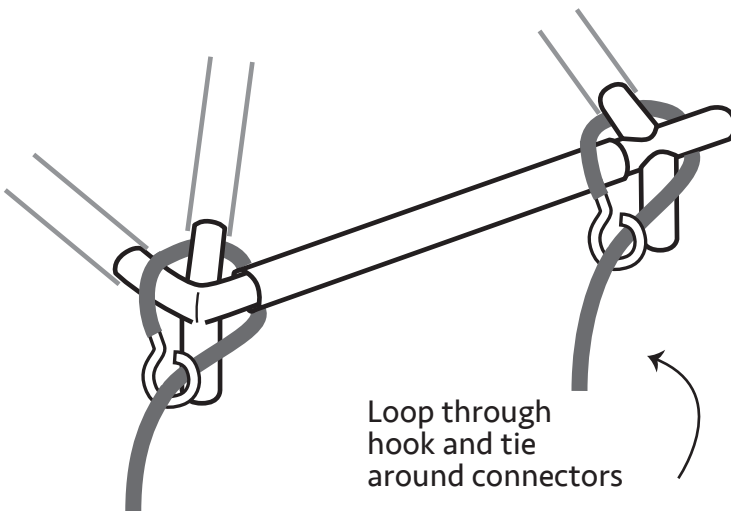

Loop through hook and tie around connectors

- While frame is still on the ground, tie anchor ropes to the frame
- The ratchet straps will be secured to the tent stakes at the end of the assembly
- One rope per leg pole
- The straps go under and over, to prevent them from sliding away from leg— see (**drawing**)

Note: this step can occur after the leg poles have been installed and the frame is elevated

STEP 7. CANOPY

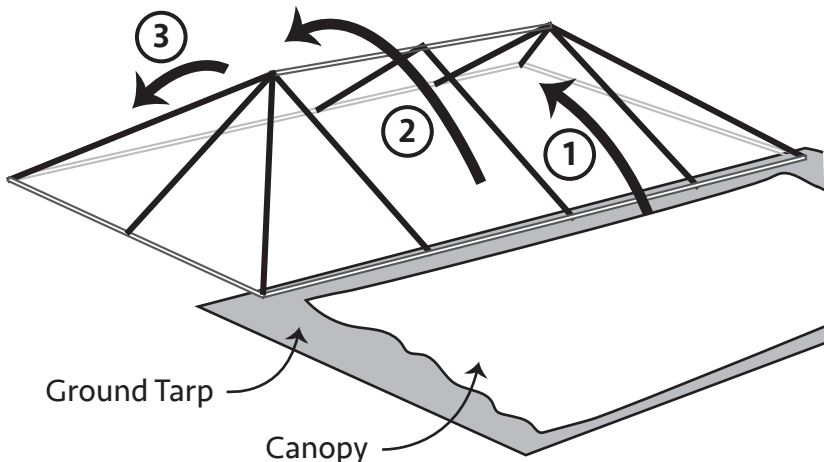

Ground Tarp

Canopy

- Once again, while frame is still on the ground, lay down a tarp(s), to protect canopy—arrange canopy along one of the long sides of the tent
- Place a ladder(s) next to ridge spreaders —as many as it takes to easily to pull canopy over ridge
- One person needed for every 10ft of tent
- 1) In unison, pull canopy up one side— ‘flapping’ in the beginning, to create lift —then stop
- 2) Have most people stay on the ground, and a couple people on ladders—pull canopy over the ridge
- 3) Pull down the other side—‘flapping’ for all three steps

STEP 8. CANOPY CONNECTIONS

(PE canopy)

PE canopies use Bungee Ball connectors

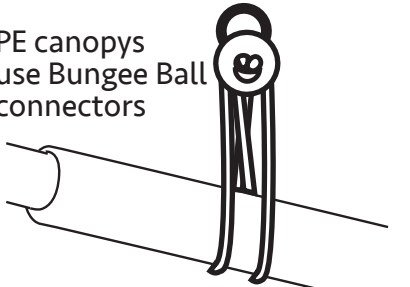

Start with one at each corner and center fittings

(PVC canopy)

Under canopy there will be several Spring Buckle Straps

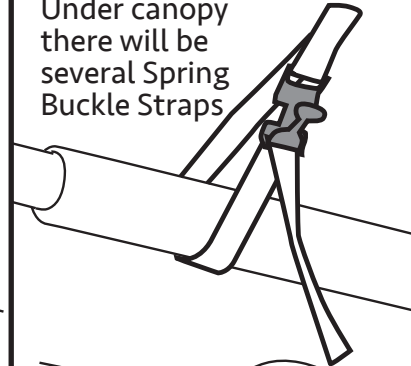

Start with one at each corner and center fittings

- After canopy is pulled over frame and corners are pulled into position, velcro corner seams together, loosely—tighten after legs are installed
- The canopy should be attached to the frame, before legs are connected—secure some of the buckle straps/bungee ball, to keep canopy in place—start near corners and center fittings
- Buckle straps/bungee balls should be located on the underside of canopy
- Secure the remaining straps after legs are installed on one side and secure—it's easier at this height—Final tightening happens after legs are installed (**step 10**)

STEP 9. BASE PLATES

Insert leg poles into base plates — screw tightens to outside of leg

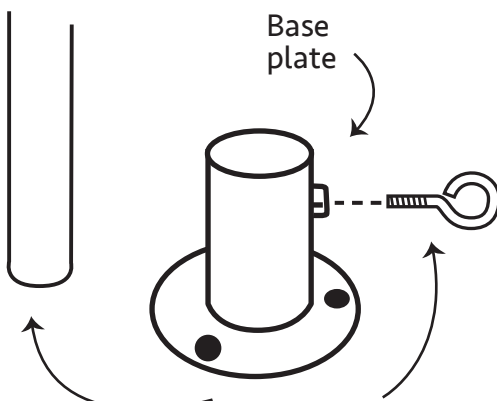

Connect all the base plates to the leg poles — using eye-screws

- Before the tent is raised, prepare the leg poles
- Place poles on top of base plate and secure with eye-screws
- Do this for all the leg poles
- Once tent is erect, use the smallest hook stake to secure legs to ground

STEP 10. INSTALLING LEGS (smaller tents)

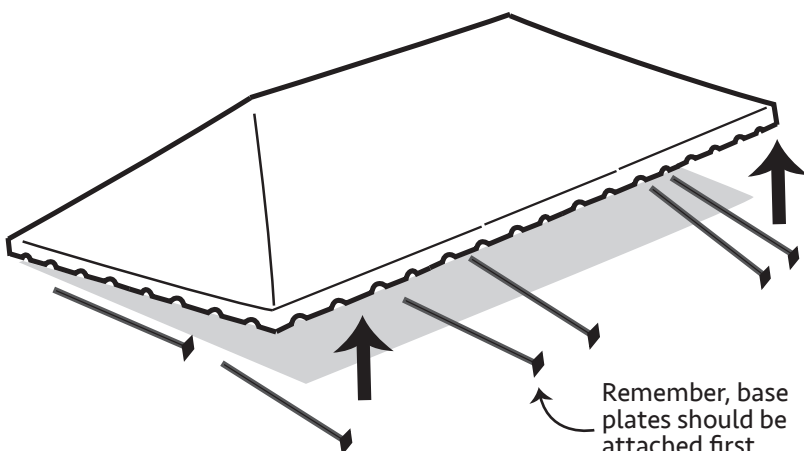

Remember, base plates should be attached first

- For smaller tents, (10x10, 10x20, 20x20) three or four people should be able to raise the frame and install the leg poles
- Locate one of the long sides of the frame—this will be raised first, while the opposite side remains on the ground
- **Important:** Lift the entire side of the frame at once (not one corner)
- Install all the legs on this side—secure with 'R' pins—
- Repeat for opposite side, then install legs for the remaining two sides
- *Double check the canopy corners—pull them down tight and straight—secure velcro at corners*
- **Important:** tighten spring buckle straps or bungee balls— for security and to help pull canopy corners into place

STEP 10. INSTALLING LEGS (20x20 and larger tents)

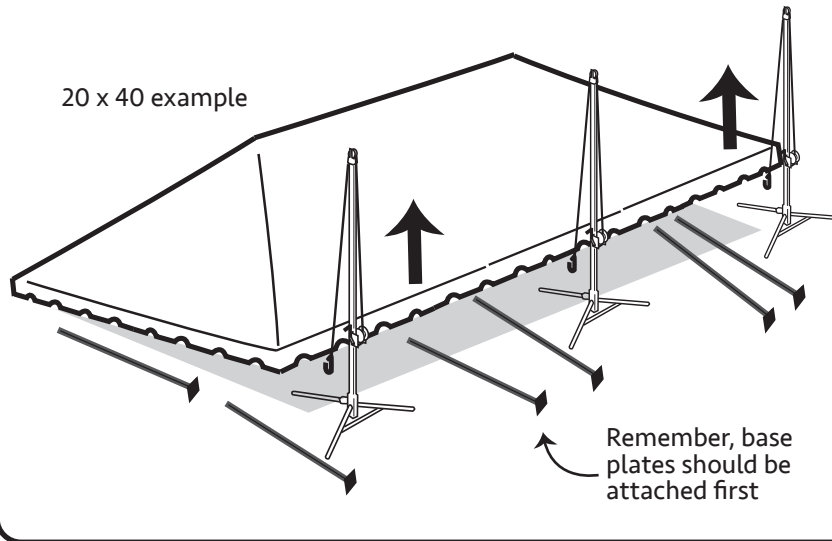

- For larger tents, (20x20 and larger) frame tent jacks should be used to raise the frame and install the leg poles
- Locate one of the long sides of the frame—this will be raised first, while the opposite side remains on the ground
- **Important:** Lift the entire side of the frame at once (not one corner)—crank jacks in unison
General rules are; work on the long side, one side at a time, and never place jack in the middle of a spreader bar
- Install all the legs on this side—secure with 'R' pins
- Repeat for opposite side, then install legs for the remaining two sides
- **Important:** tighten spring buckle straps—for security and to help pull canopy corners into place

STEP 11. STAKE LINE

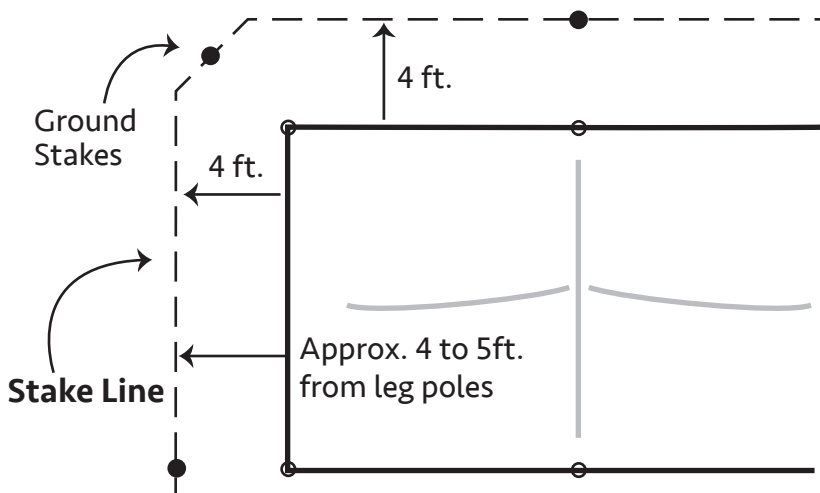

- **Double check leg poles**—making sure each pole is straight and lined up correctly, while tent jacks are still handy
- Once the tent is vertical and all the leg poles are attached, begin the process of staking the tent—with plenty of hands on deck, lift and adjust tent position if needed, first
- Measure 4 ft. out from each leg pole and place a stake in the ground
- Stakes should look uniform, around the tent—and 6 inches above ground see (figure B)
- Stakes should then be hand hammered or for larger installs, use a stake driver

FIGURE B. HAMMERING STAKES

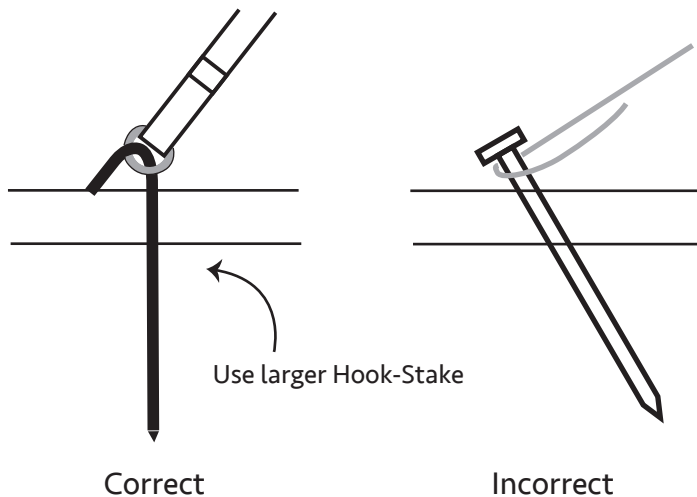

- Ground stakes should be hammered in vertical, not angled (sledge hammer required)
- Complete the hammering process by driving the stakes in and make contact with the ground, for extra security

STEP 12. SECURING ROPES

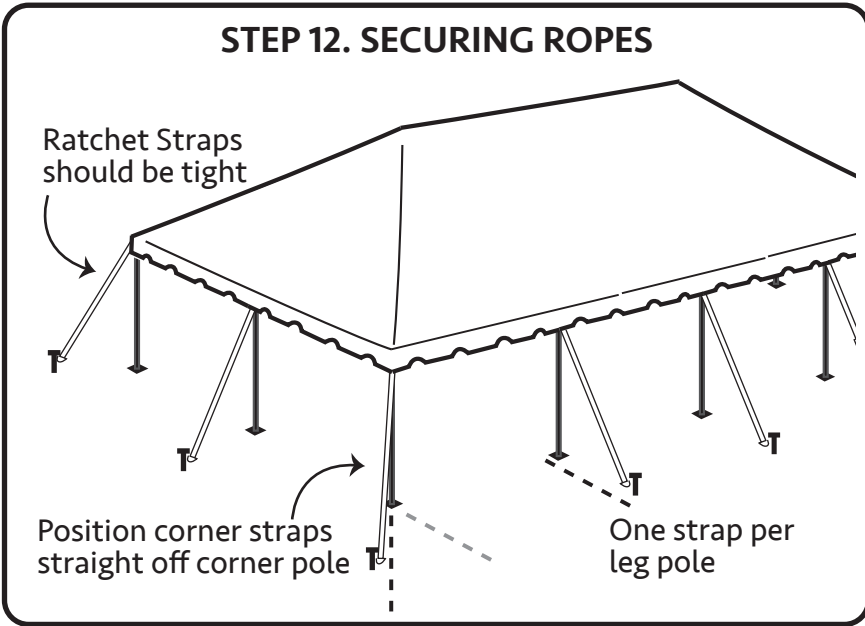

- As the assembly nears completion it is time to tighten all ratchet straps
- Keep an eye any lean that might be caused by the tightening process
- Go around the tent, make adjustments for any leg pole and tent lean
- Finally, secure any remaining spring buckle straps/ bungee ball connector, under the canopy, that were not secured in step 8
- See **(figure C)** for additional ratchet strap use

FINISHED TENT

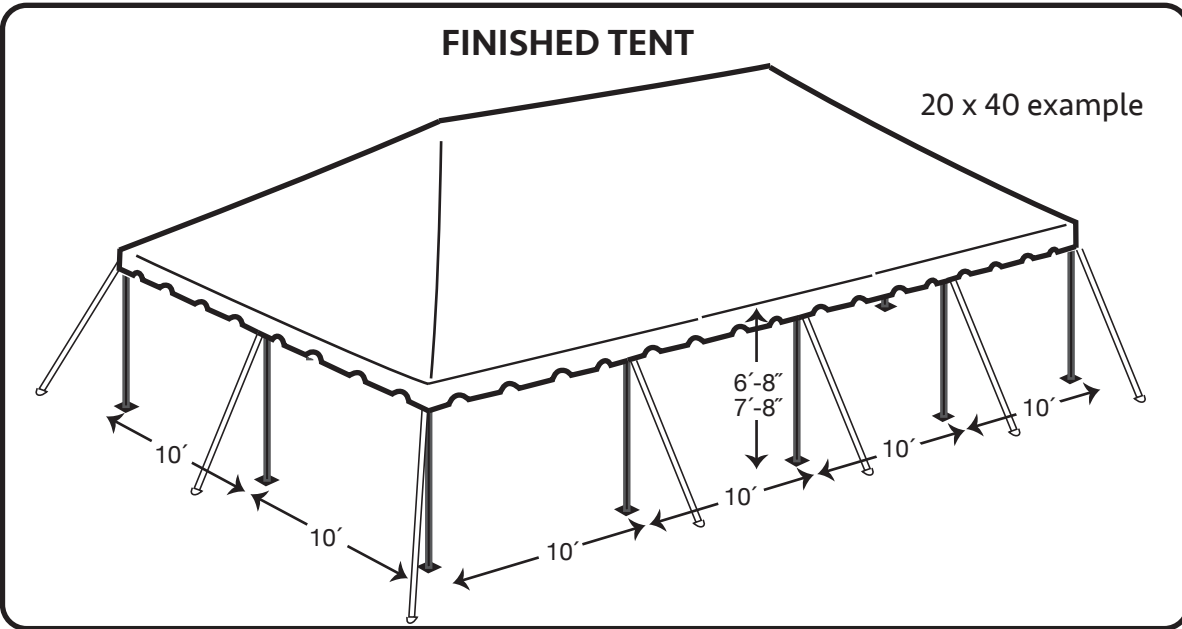

STRIKE PROCEDURE (basically, reverse order from assembly)

- 1.) Undo ratchet strap assemblies/untie ropes
- 2.) Unfasten spring buckle straps, under canopy
- 3.) Remove leg poles, on one long side
(use tent jacks for larger tents)
- 4.) Remove adjacent center, leg poles, on short sides
- 5.) Lower first long side to the ground
- 6.) Repeat, remove leg poles, on remaining long side
- 7.) Lower rest of frame to ground
- 8.) Lay tarp next to a long side of frame
- 9.) Loosen canopy corners
- 10.) Slowly slide canopy off frame—
flapping, in unison, as you go
- 10.) Fold and bag canopy (dry canopy)
- 11.) Disassemble poles and connectors
- 12.) Remove ground stakes

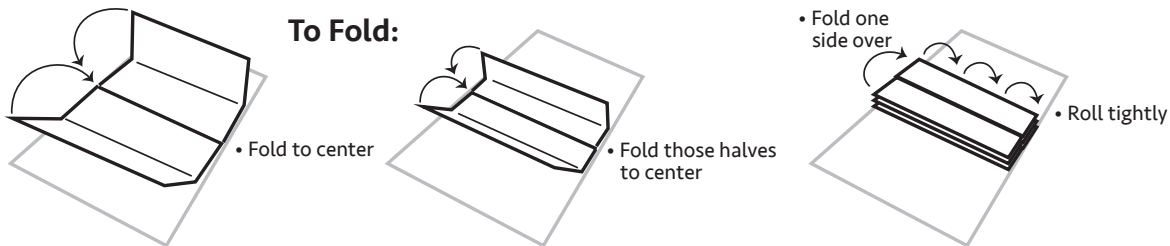
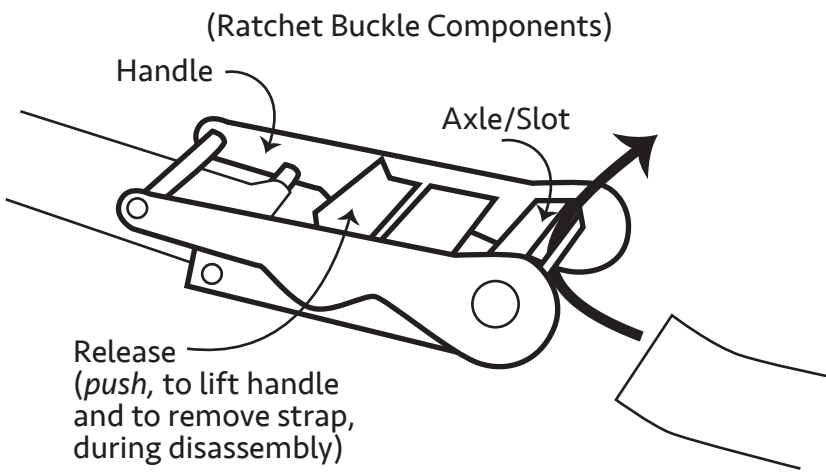
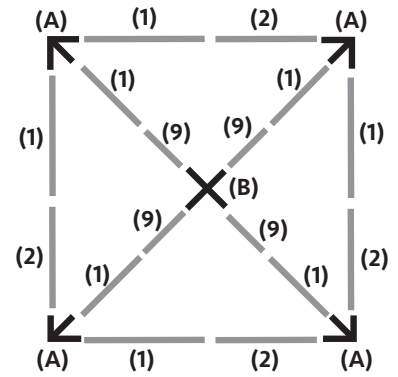
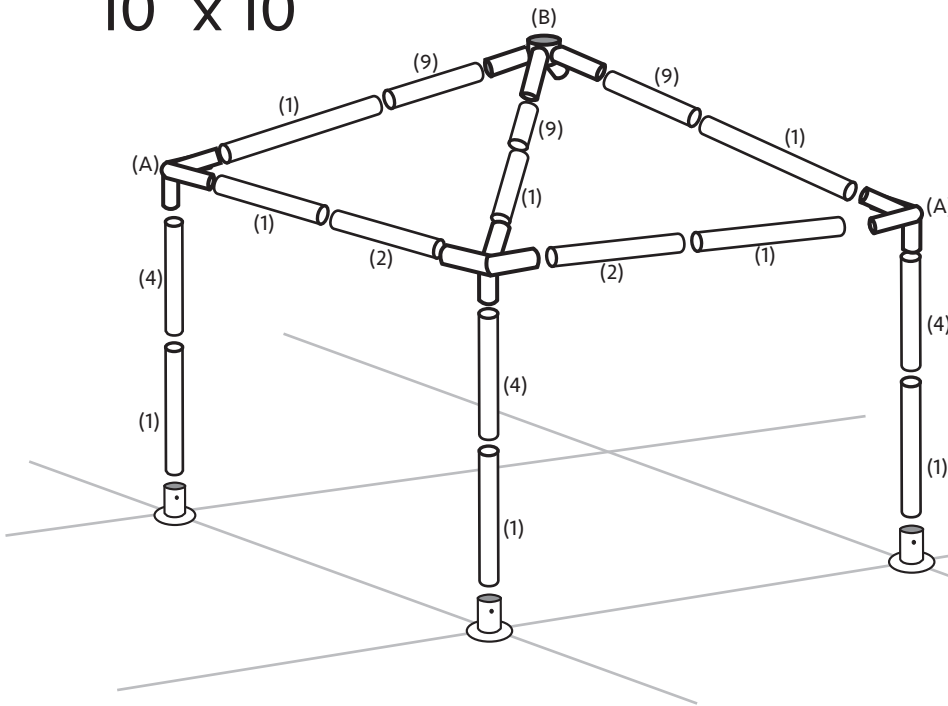

FIGURE C. USING RATCHET STRAPS



- Release handle, crank until slot is pointing up
- Close handle
- Pass strap underneath and through the slot (as shown)
- While holding the whole strap assembly attach both ends (eg. tent to stake)
- Remove slack, before tightening
- Push 'release'— lift handle and tighten ratchet
- Roll-up any excess strap, put under handle
- Close handle

Weekender-WCF Frame Tent 10' x 10'



Weekender-WCF Frame Tent 10' x 20'

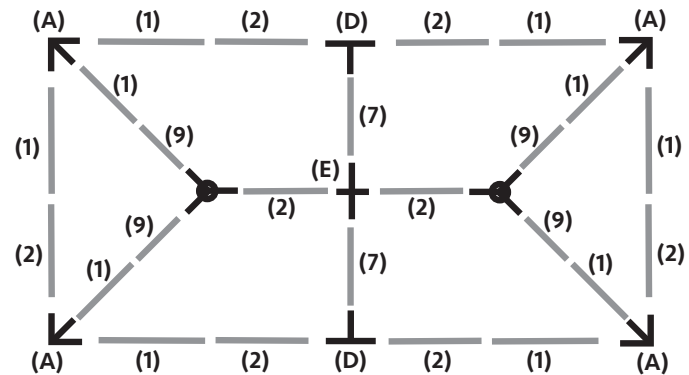
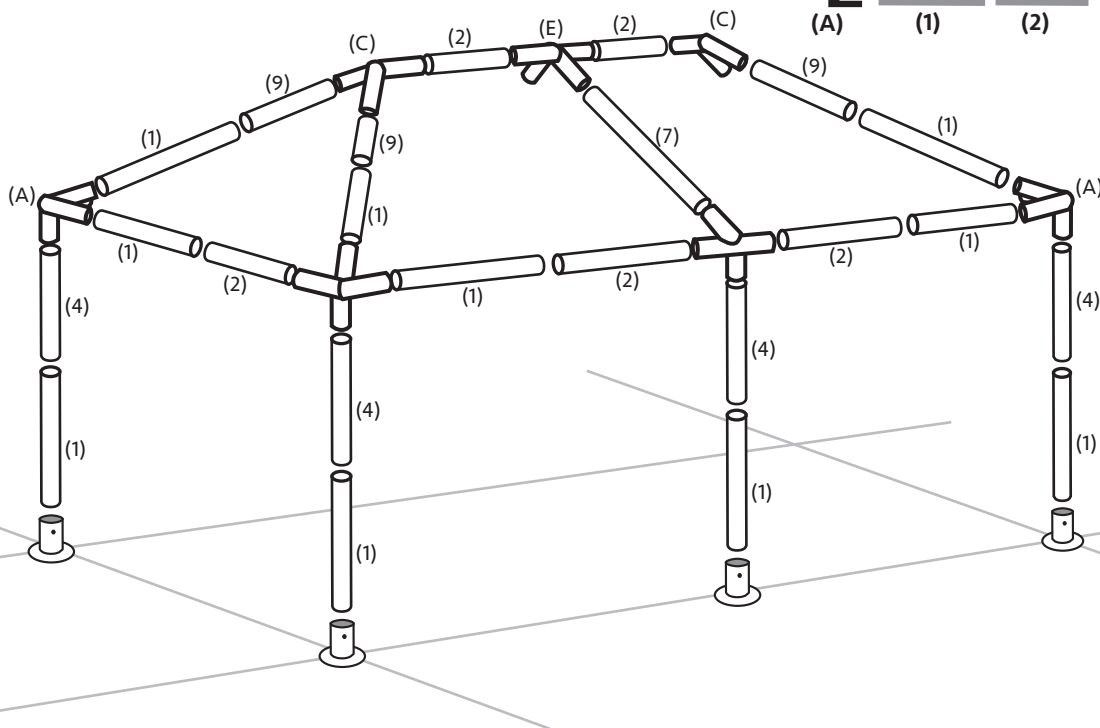

Weekender-WCF Frame Tent 20' x 20'

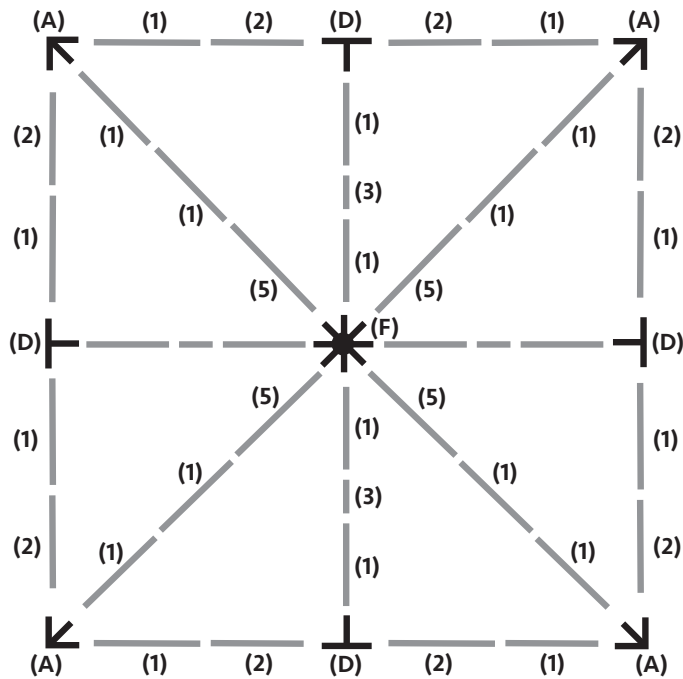
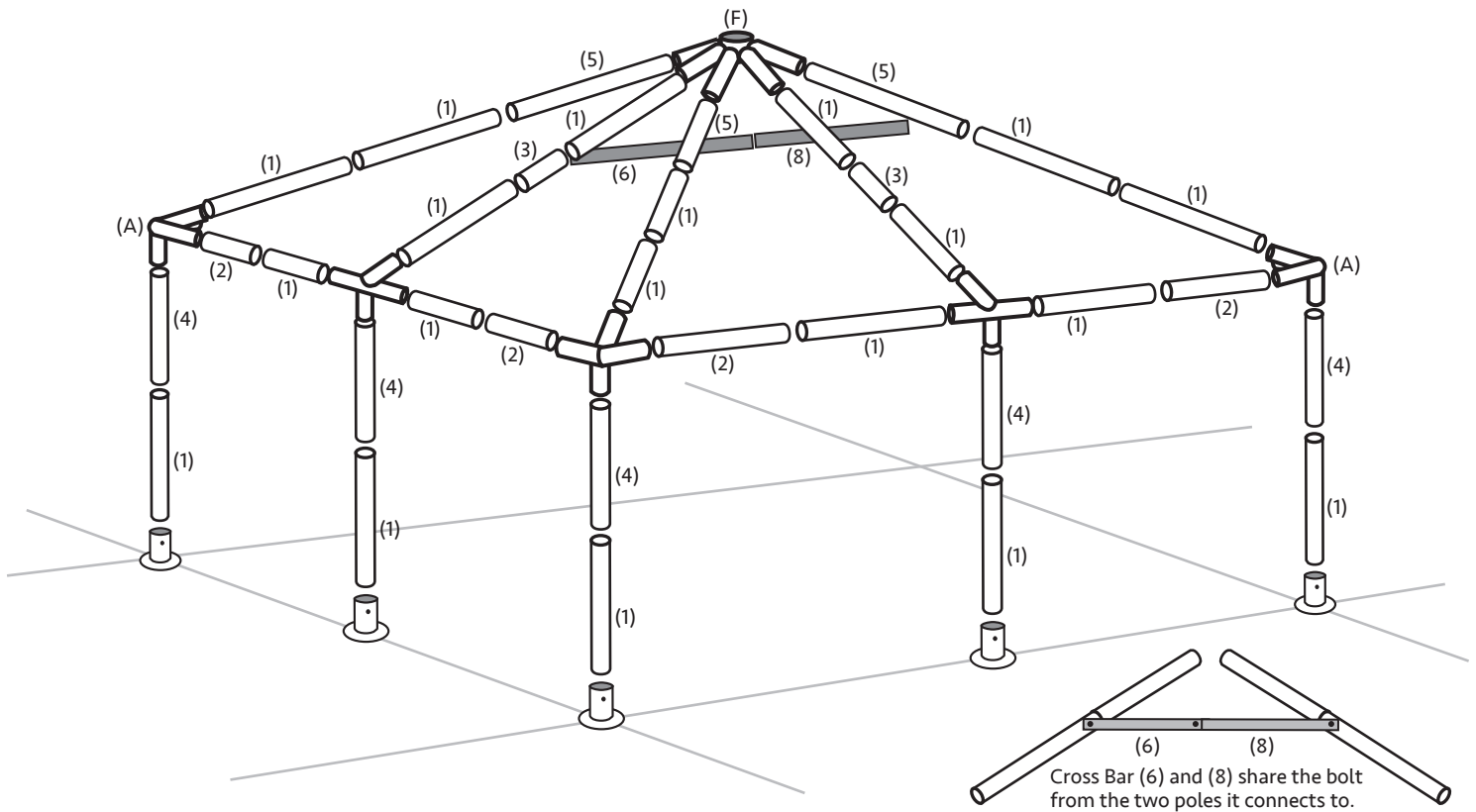

Weekender-WCF Frame Tent 20' x 30'

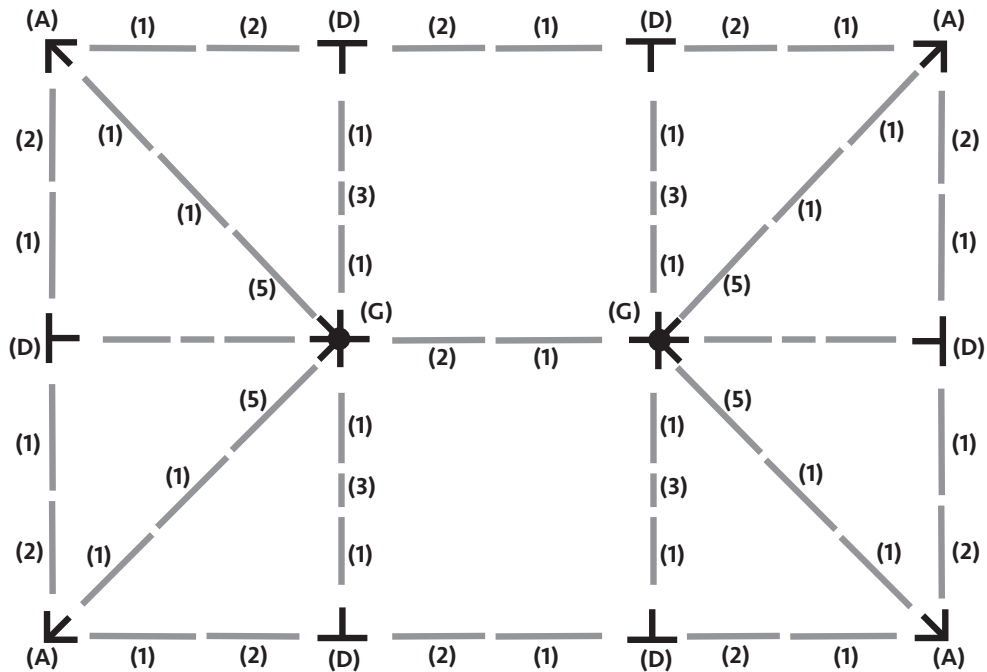
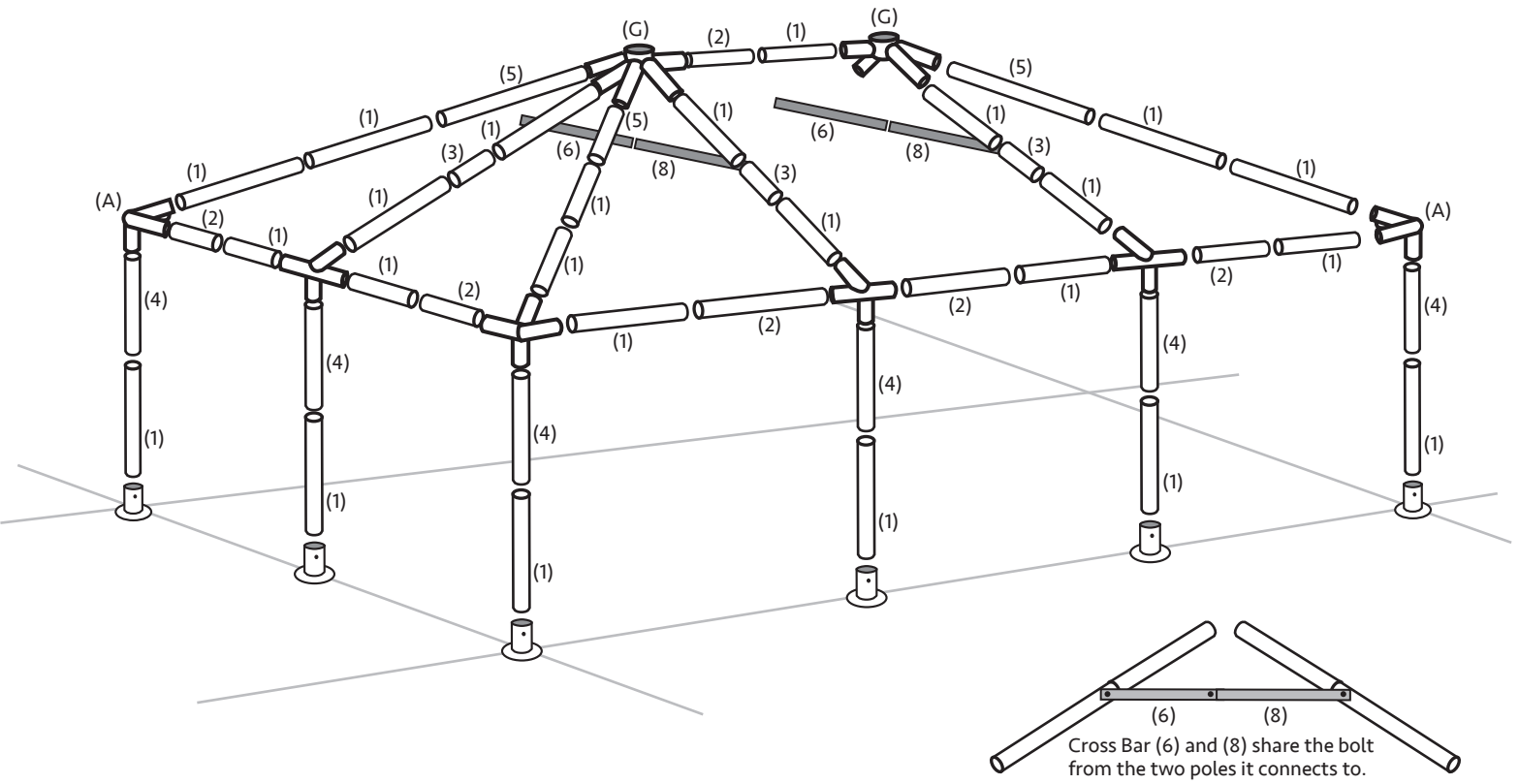

Weekender-WCF Frame Tent 20' x 40'

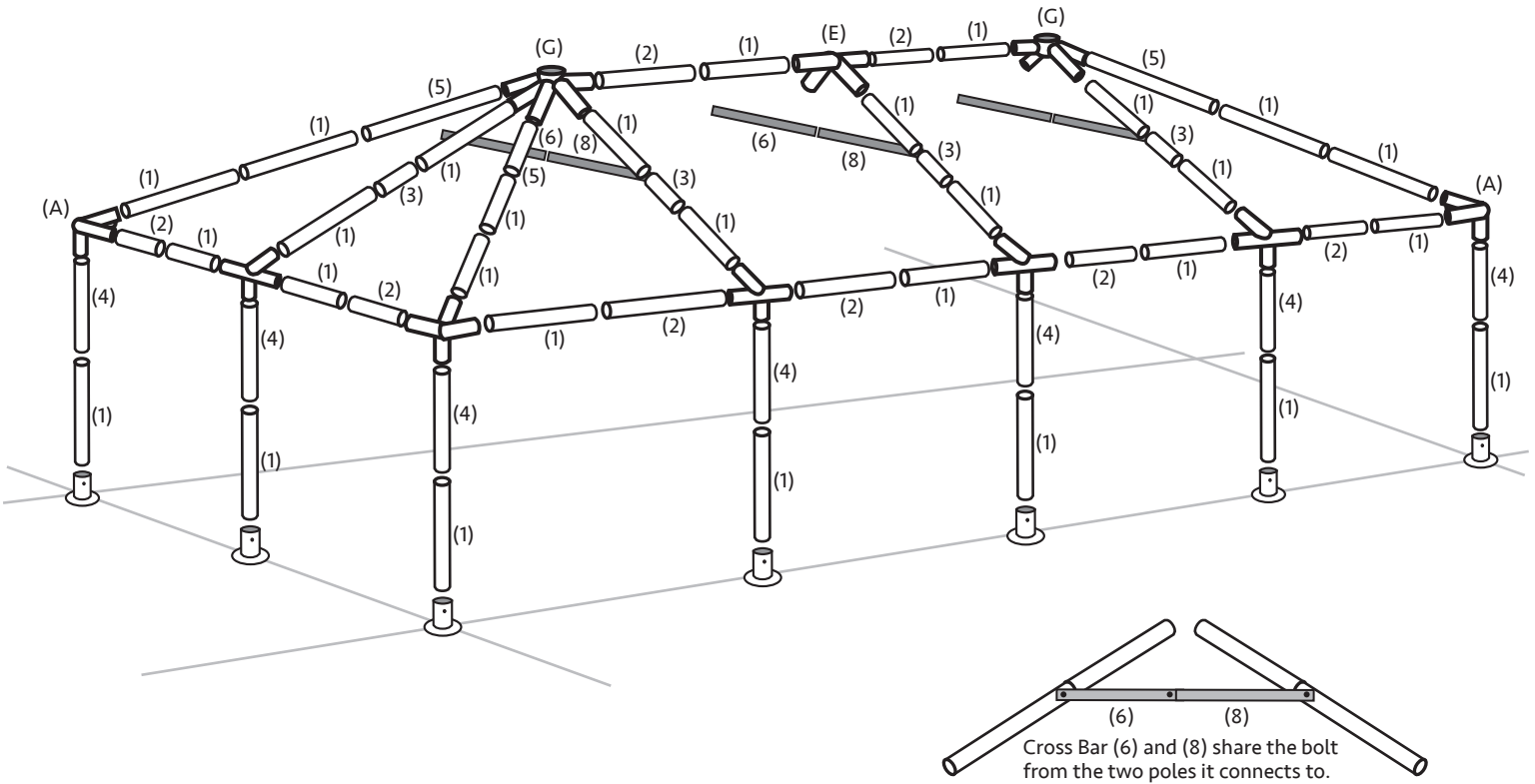

WC Steel Frame Tent – 20' x 40'

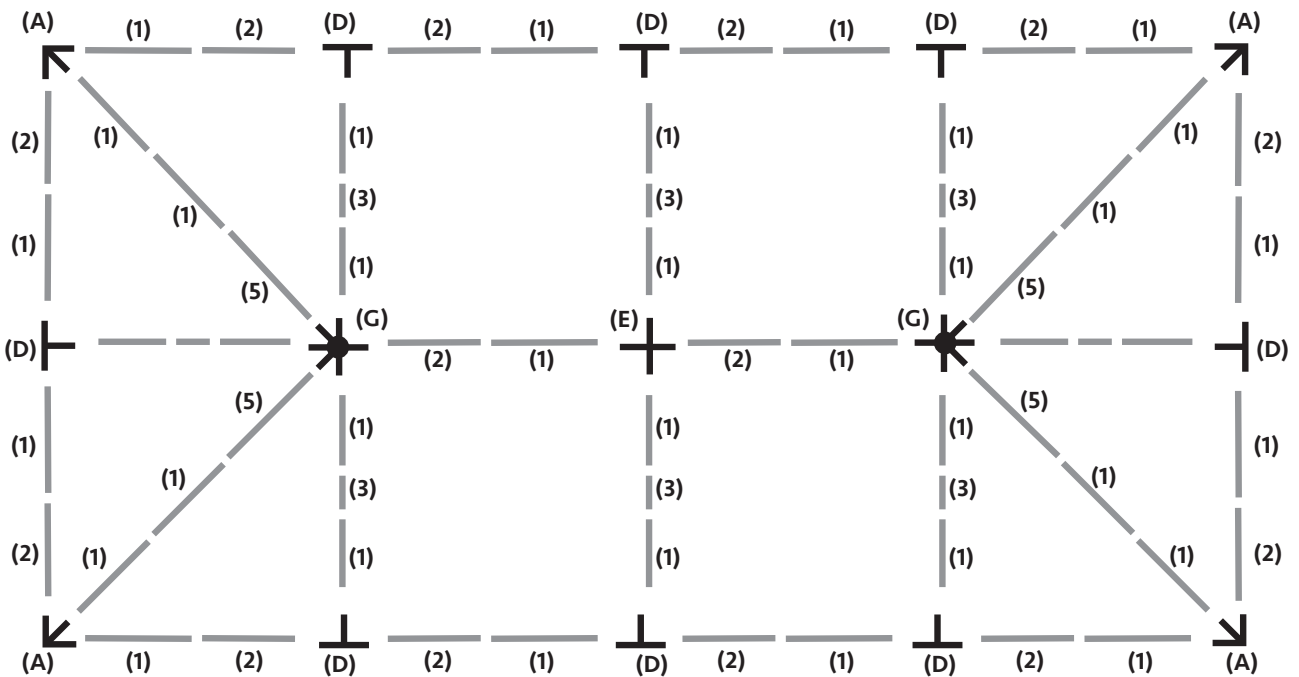

Weekender-WCF Frame Tent 20' x 60'

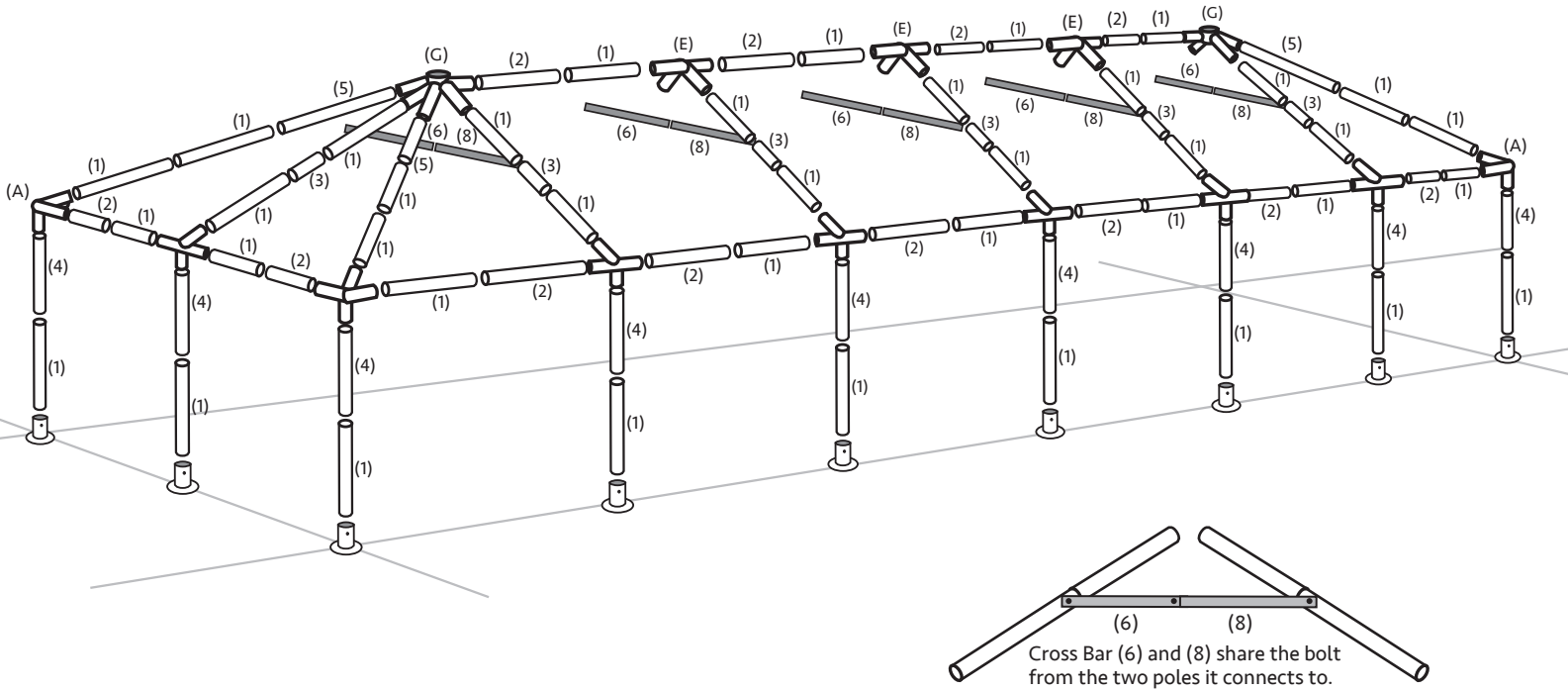

WC Steel Frame Tent - 20' x 60'

