

HIGH PEAK FRAME TENT

20' x 20'

ASSEMBLY INSTRUCTIONS





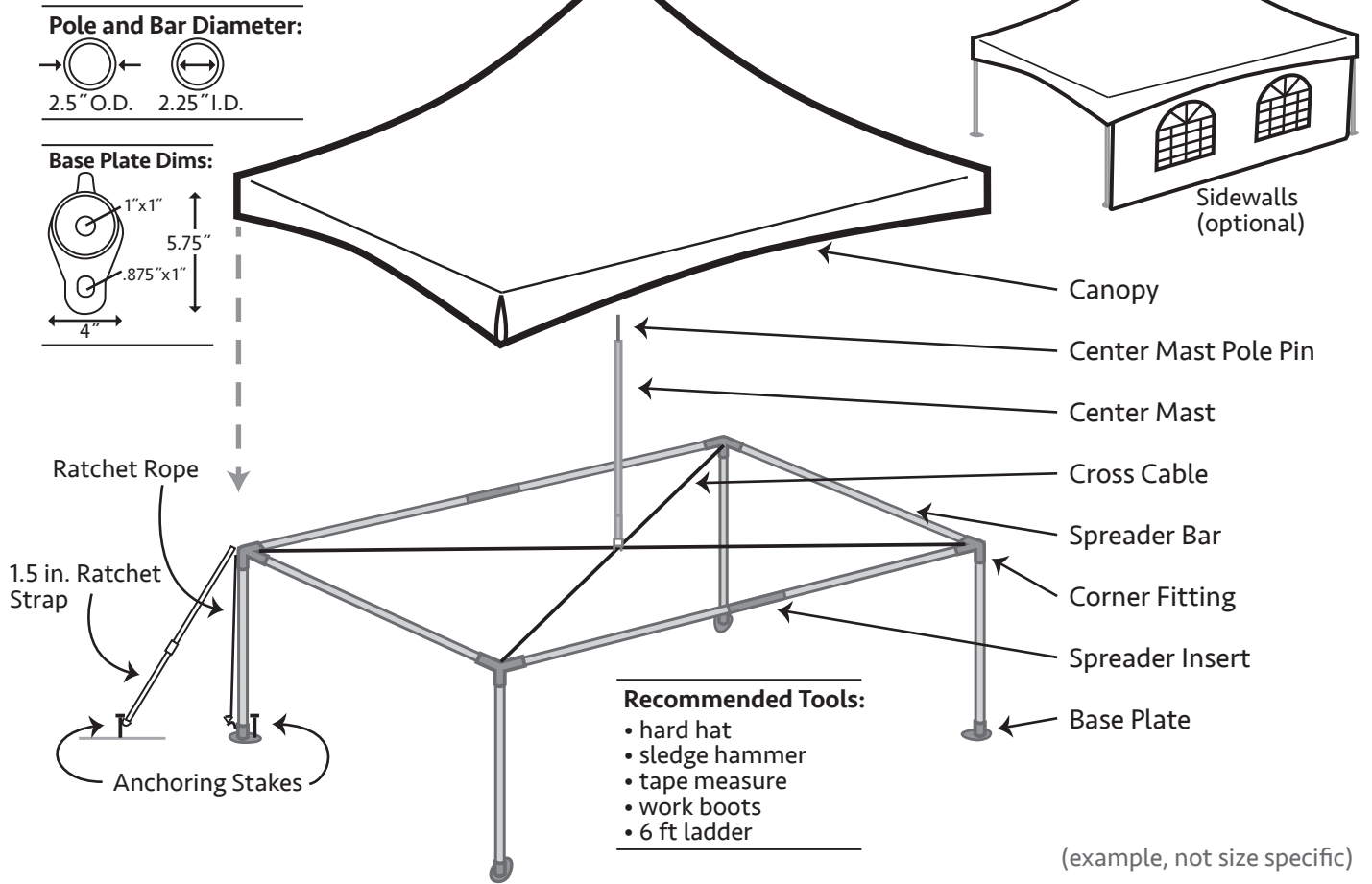



High Peak Frame Tent (OVERVIEW)

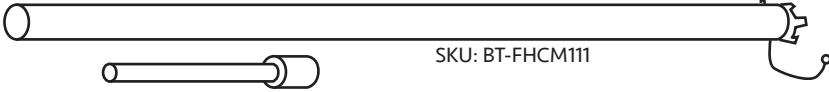
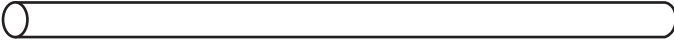

High Peak Frame Tent (SPECIFICATIONS: 20x20)

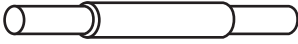
Width	20 ft. / 6.1m	Fabric Material	PVC Coated Polyester
Length	20 ft. / 6.1m	Fabric Material Weight	16 oz. / yd ² / 540 gsm
Area	400 ft ² / 37.2m ²	Fabric Translucency	Block-out
Eave Height	8' / 2.4m	Water Repellency	Waterproof
Overall Height	16' 9" / 5.1m	Snow Load	None
Pitch	8' 9" / 2.7m	Flame Resistant	Yes
Complete Weight	326 Lbs. / 148 Kg.	UV Resistant	Yes
Series	High Peak/Prestige	Mold and Mildew Resistant	Yes
Class	Cross Cable	Frame / Pole Material	Aluminum
Center Pole	No	Longest Component	9'3" / 2.8m
Style / Shape	High Peak Frame Tent	Persons required for setup	2-3
Expandable	No	Occupancy	40 Sit Down Dinner
Custom Printing Available	Yes	Occupancy (cont.)	67 Cathedral Seating

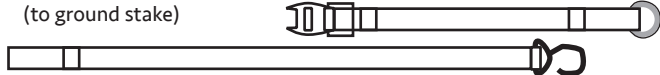
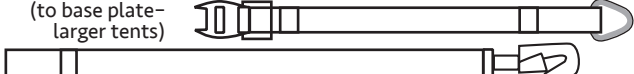
STEP 1. CHECK ITEM LIST (20' x 20' High Peak Frame Tent)

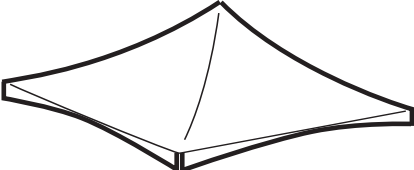
Item	Illustration (all parts available for replacement)	Item Size	Quantity
Eave Spreader Bars	 SKU: BT-FHAST111 (9'-3")	9'-3"	8
Center Mast Pole and Center Mast Pin	 SKU: BT-FHCM111 SKU: BT-FHCMPP (pin) SKU: BT-FHCMPPP (plug) SKU: BT-FHCMB (bottom)	111"	1
Leg Poles	 SKU: BT-FHAST8L	8'	4
Corner Fittings	 SKU: BT-FHCRN	Std.	4
Side Tee Fittings			None
Spreader Insert	 SKU: BT-FHSI	Std.	4
Cross Cables	 SKU: BT-BT-FHCC328	328"	2
Base Plates	 SKU: BT-FHBP	Std.	4
1.5" Ratchet Strap Assembly w/ D-ring	(to ground stake)  SKU: BT-TARS15	1.5"	4
1.5" Ratchet Strap Assembly (for base plate)	(to base plate—larger tents)  SKU: BT-TARS15	1.5"	4
Ratchet Rope (smaller tents only)			None
Base Stake	 SKU: BT-FHSTK1	3/4" x 20"	4
Ground Stake	 SKU: BT-FHSTK2	3/4" x 24"	4
Corner Bar (unique)			None
Canopy Top	 SKU: BT-FH22WTT	20' x 20'	1

STEP 2. SAFETY CHECK LIST



- When building or assembling anything above shoulder height, wear a hard hat
- Steel toe boots are recommended
- Inspect the site, look for overhead and underground obstructions— such as utilities
- Call your local utility to have utility lines marked (call 3–5 days ahead)— **call811.com** is a good resource— ‘click’ 811 in Your State
- Inspect all ropes and tie lines
- Inspect poles, making sure there are no bends or breaks
- Replace or repair any items in poor condition

STEP 3. CONNECT EAVE BARS (20x20)

Position tarp in the exact tent location desired
(use small objects as weights on a windy day)

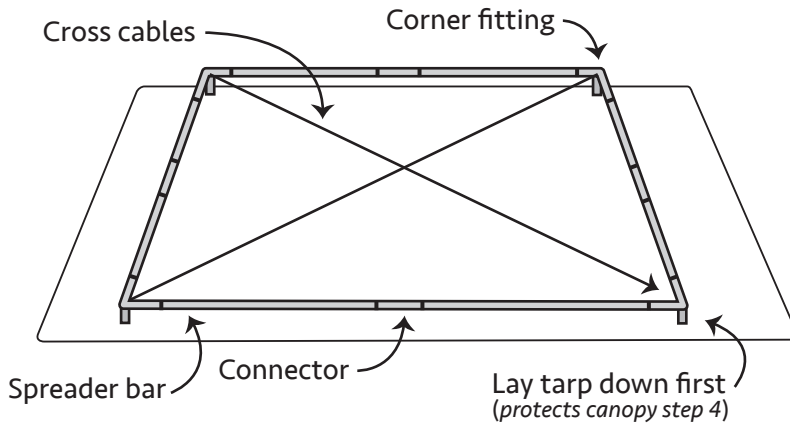

- Spread tarp (*sold separately*) in the tent location, to protect canopy— tarp/tarps should be as large as canopy
- Place eave bars, corner fittings, side fittings and connectors on tarp
- Connect all fittings
- See (**appendix A**) for your tent plan, eave bars layout and more information
- The last cable is attached differently see (**figure A**)

(FIGURE A.)

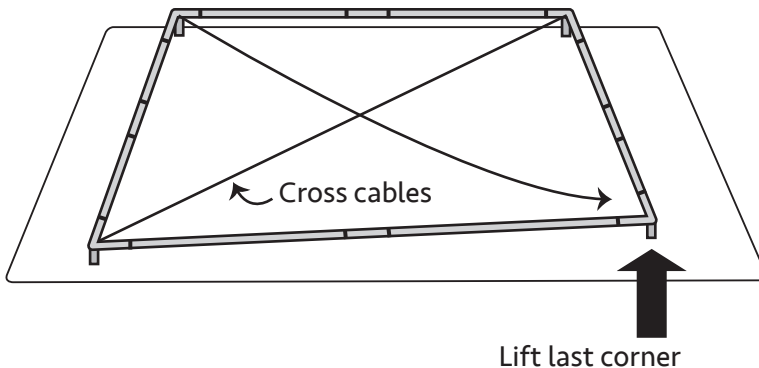

- Because of the tension build-up, the last cable is connected easier in this manner
- Lift the last corner, 3 feet or higher to connect the last cable end to the corner hook—
Lifting corner actually reduces the distance between the two corners

STEP 4. CANOPY TOP

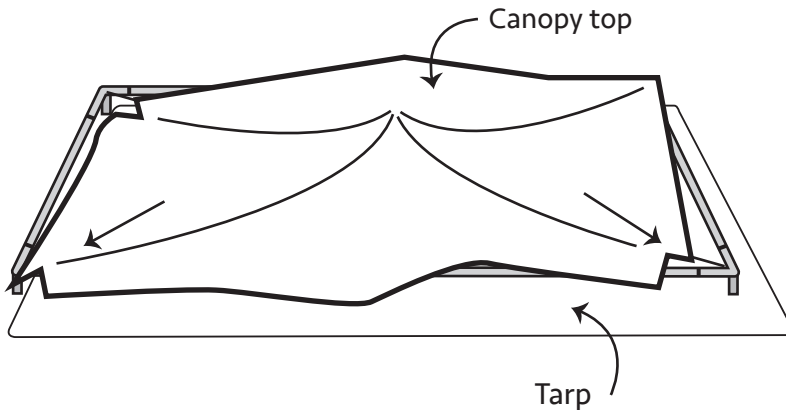

(example, not size specific)

- Unfold canopy top, place over cross cables and tarp
 - DO NOT walk on canopy
 - Center the top and stretch to edges (flap as you go, to create 'lift')
- Note: Locate the O-ring pull strap attached to one of the corner loops, that should be the **last** loop to be put in place—the strap can be used to pull the loop in place
- Connect three corners first, to the corner fittings
 - See **(figure B.)**
 - The last corner requires the use of an anchoring stake

(FIGURE B.)

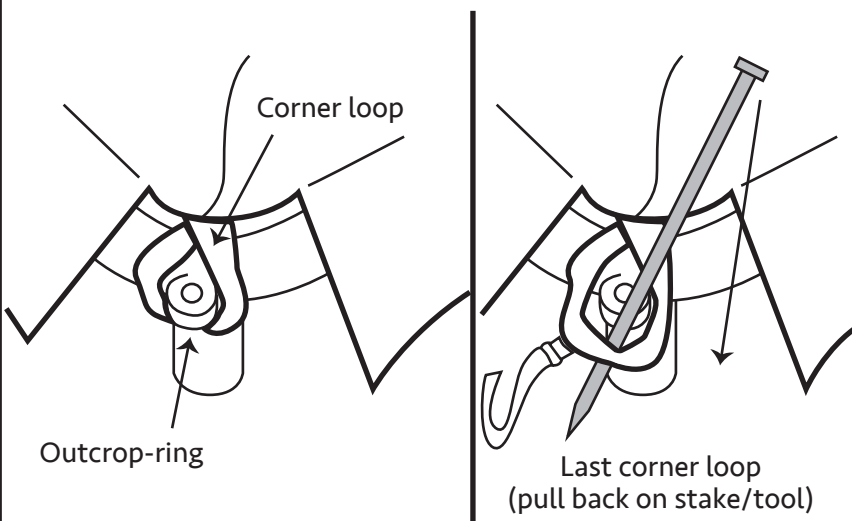

- Pull the first three corner loops over the corresponding outcrop-ring
- For the last loop, place an anchoring stake through loop and against outcrop-ring
- Pull corner loop and pry at the same time— (pull stake back, away from tent) — the overall canopy position should be straighten, this will help with final loop
- Finally, push loop in place and slide out anchoring stake
- Use O-ring pull strap to pull the loop into place

STEP 5. POSITIONING STAKES

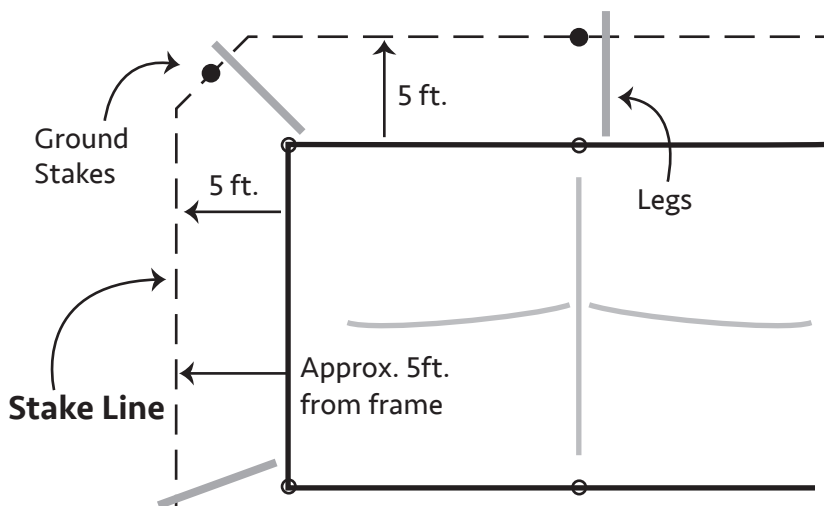

(example, not size specific)

- With the canopy on and the frame in place, measure for ground stake location
- Lay leg poles around frame to help guide your measurement
- Measure 5 feet straight out from frame, at each leg connector
- Slide stakes through D-ring of 1.5" ratchet strap, before you continue
- Remember, one ground stake per leg pole at the stake line, see **(figure C, next page)** for proper staking

STEP 6. ATTACHING 1.5" STRAPS

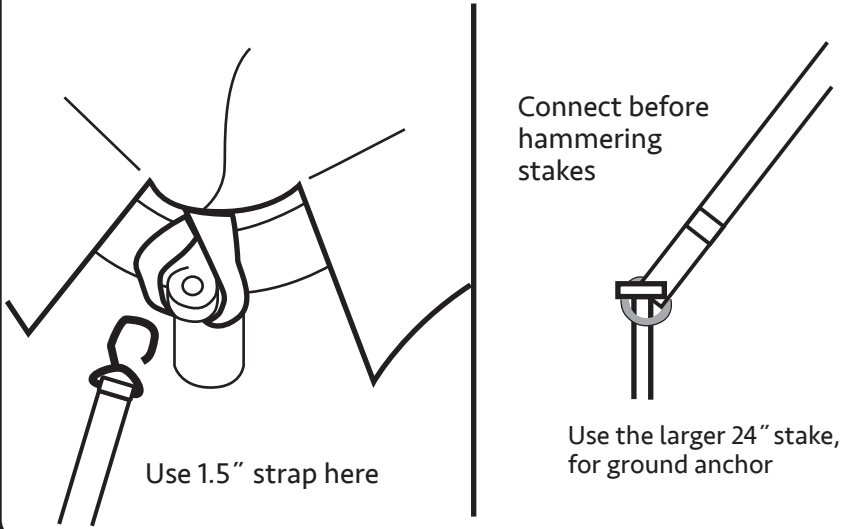

- At this time, finish sliding the stakes through all of the D-rings, that are connected to the 1.5" straps
- Hammer all stakes in position (half-way)
- Attach the *hook end* of the 1" ratchet strap assembly to all outcrop rings
- Connect straps together, using ratchet

See (page 7) for Ratchet Strap use

- This makes complete 1.5" ratchet strap assemblies, both ends connected—leave a good amount slack, for now

(FIGURE C.)

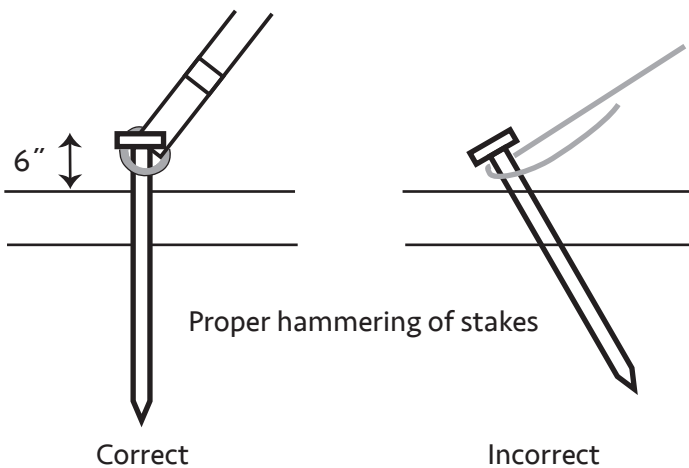

- Ground stakes should be hammered in vertical, not angled (sledge hammer required)
- Determine the longest side of your tent—this is were the first two leg poles will be installed—
Check connection of 1.5" ratchet strap, from frame to ground stake, before these two legs are installed
- Complete the hammering process, before you install each leg—leave 6 inches showing, above the ground

STEP 7. INSERTING LEG POLES

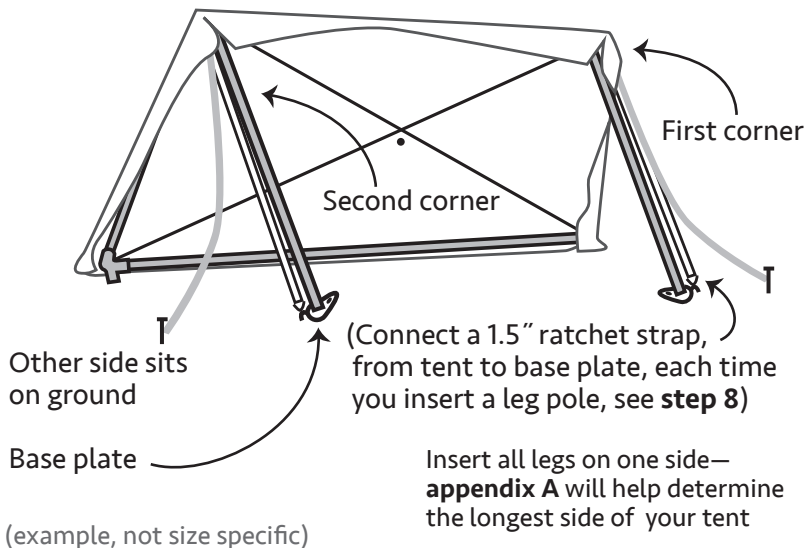

- Lift 'first' side of frame
- Insert legs on one side (*remember pick the longest side, for rectangular tents*)
- Slide base plate onto these legs—anchor hole should be facing interior of tent
- 1.5" Ratchet straps should have some slack in them, at this point still
- Continue with 'second' corner & side legs
- The center pole goes in, before the leg poles on the other side

Note: Large tents require *frame tent jacks*—general rules are, one jack every 20' and never place jack in the middle of bar (usage can be found on Internet)

(example, not size specific)

STEP 8. BASE PLATE STRAPS

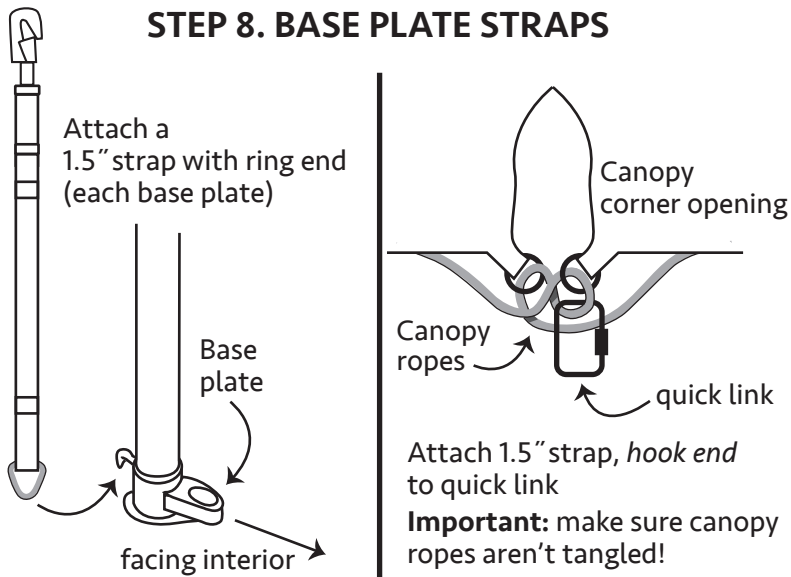

- For every leg pole, there is a base plate and a 1.5" ratchet strap assembly—connect the straps as each leg is installed
- Connect *hook end* to quick link and *ring end* to base plate hook (check that *canopy ropes* are not tangled)
- Tighten strap, before moving to the next leg (not at 100%—secure fully at the end of assembly)

See (page 7) for Ratchet Strap use

STEP 9. POSITIONING CENTER POLE

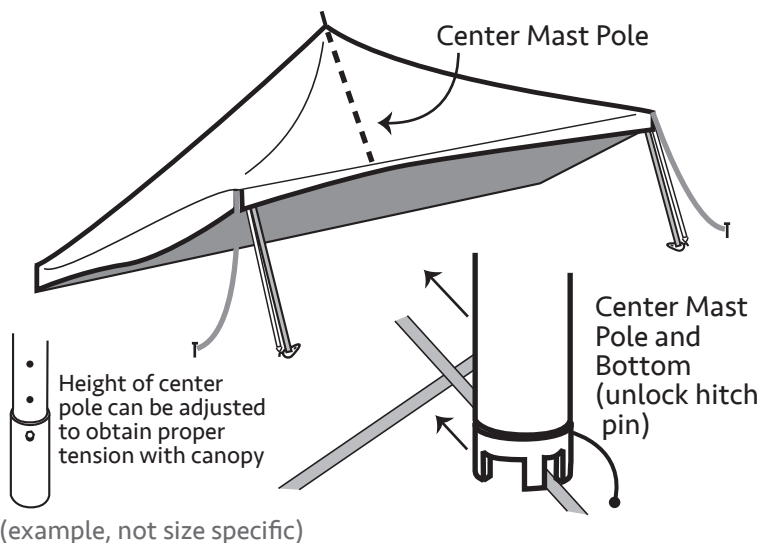

- One side of canopy still remains on tarp
- Lift center mast (two people will get this step done quicker)—walk under canopy, keeping the pole angled
- Insert mast pin into grommet at center of canopy (make sure entire pin is through and visible from outside)
- With the pole at an angle (not vertical), lay notched bottom near the outer end of the top cable—then slide the bottom of pole towards the center
- Make sure mast pin stays in place
- At center, where cables cross, position notched bottom over all the cables
- Lock hitch pin around cables to the other side of center pole bottom

STEP 10. INSTALL REMAINING LEGS

(Connect a 1.5" ratchet strap, from tent to base plate, each time you insert a leg pole)

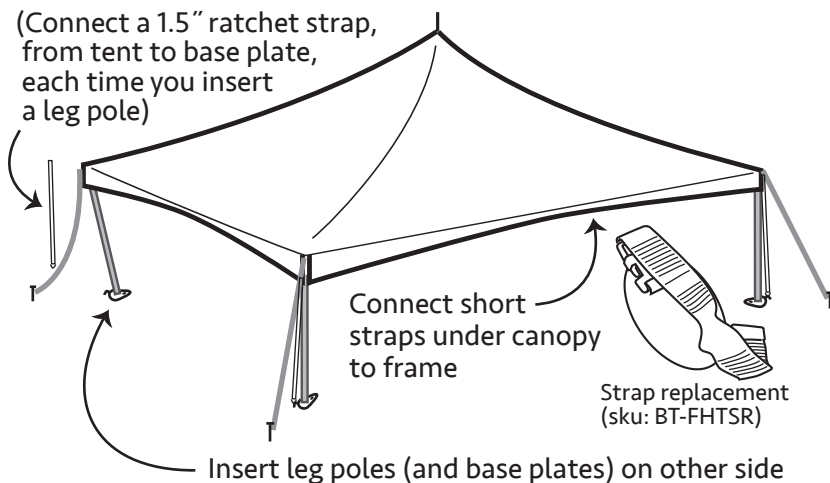

- Under canopy you will see several short 'side release buckle straps'—connect these to frame (eave bars)
- Raise other side of tent (2 people required)—start at a corner
- Insert leg poles—**the leg poles should be vertical at this step**
- Slide base plate onto these legs—secure canopy to remaining base plates, with corresponding 1.5" strap, at each leg
- **TIGHTEN ALL 1" and 1.5" RATCHET STRAPS**
- Fully tighten short straps, under canopy
- Lastly, secure base plates to ground by hammering in the 'base stakes'

WIND / RAIN / SNOW – IMPORTANT INFORMATION!:**WIND!**

Wind can cause the ratchet assemblies and stakes to loosen, or cause the poles to **sink** or shift through constant movement and vibration – the tension of the tent will be negatively altered.

Follow these steps to provide extra security and safety during windy conditions:

- Very important, do routine maintenance checks – be sure to check proper tension regarding the ratchet assemblies, throughout the day/event. This is critical, if your tent must stay up, in moderate windy conditions.
- In the case of strong winds, remove any sidewalls. This will allow the wind to pass through the tent, diminishing major upward pressure on the tent top.
- Additional security can be achieved by adding additional stakes and ropes/straps to corners— and to the 'wind side' of the tent.
- When anticipating windy conditions, perform a **soil test** to determine proper staking:
 - 1.) drive a large steel stake approx. 20 in. into soil, vertically
 - 2.) measure the distance from the ground to the top of stake
 - 3.) with a 16lb. sledge hammer, strike stake with an average blow (don't over hit)
 - 4.) measure the **movement/hold strength**: (0.2in./2500lbs) (0.3–.5in./1600lbs) (0.6–1.5in./800lbs) (1.6–3in./400lbs) (3–6in./200lbs) (> 6in./100lbs) Double or triple staking might be necessary, 10in. behind primary stake (see figure D). [search web for: **tent.IFAI tent staking handbook** for detailed information]
- When SEVERE WEATHER is approaching, the TENT SHOULD BE EVACUATED— and TAKEN DOWN!

Proper Setup Note:

Make sure all poles are vertical and form a 'squared up' rectangle. (30 wide and larger: use a *Mason's* string – attach at the base of one corner pole, go around all 4 corners to form a box. Tighten the string – then align all side poles by having them touch the string). Proceed by bringing these poles vertical and applying proper tension to each strap – start at the middle of one of the short sides (2 people, same speed) and work around the tent, ending with the middle of the other short side (see figure E). **The person on the 'wind side' goes first.** Lastly, re-check the corner poles.

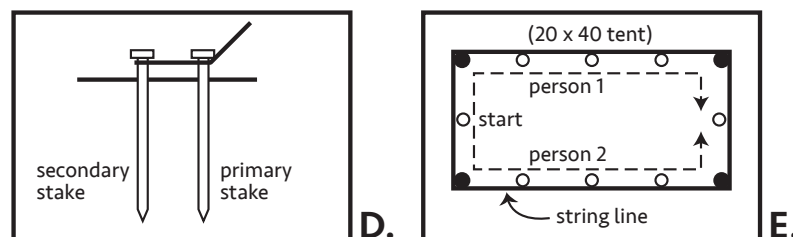
**RAIN!**

When rainwater collects on the tent canopy it causes 'ponding'— occurring in heavy weather conditions. If the tent is not tensioned correctly, this issue will be made worse. Additional weight from the water will cause the tent to sag – this may cause the poles and base plates to sink into the soil. In addition, water saturated soil will cause the stakes to lose their holding power. When you combine loosened stakes, added weight on the canopy and reduced tension on ratchet assemblies, the structure becomes a **safety hazard**. IT IS THE TENT OWNERS RESPONSIBILITY TO ASSURE THE SAFETY OF ALL INVOLVED.

SNOW WARNING: As weather can be unpredictable, the installer/end user must incorporate sound judgment regarding weather conditions. The owner is responsible for anticipating weather severity for safe usage. We do not recommend leaving our *event tents* set up in windy or adverse weather conditions. **Do not allow WATER or SNOW to accumulate on your tent top**, as this weight can destroy the tent fabric, reduce the holding power of stakes, or **collapse the tent**. Tents, canopies and temporary shelters are not designed to carry any type of snow load. These products should not be used if snow of any kind is present, and must be evacuated immediately.

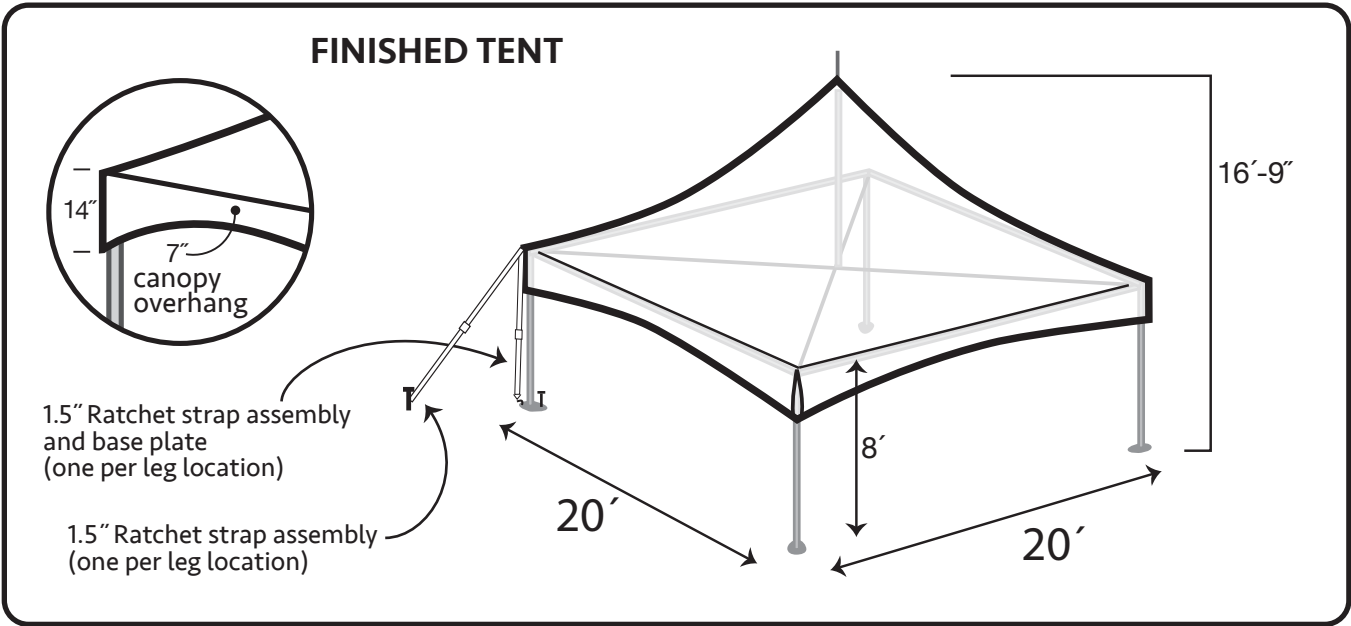

STRIKE PROCEDURE (basically, reverse order from assembly)

- 1.) Remove base stakes
- 2.) Detach short straps under canopy
- 3.) Remove straps on one side
- 4.) Remove leg poles, on one side
- 5.) Remove side leg poles, (adjacent to corner of 30 x 30 tent, only)
- 6.) Remove center mast
- 7.) Lay tarp under canopy
- 8.) Remove remaining straps
- 9.) Remove remaining legs
- 10.) Fold canopy
- 11.) Disconnect/remove eave poles and connectors
- 12.) Remove ground stakes

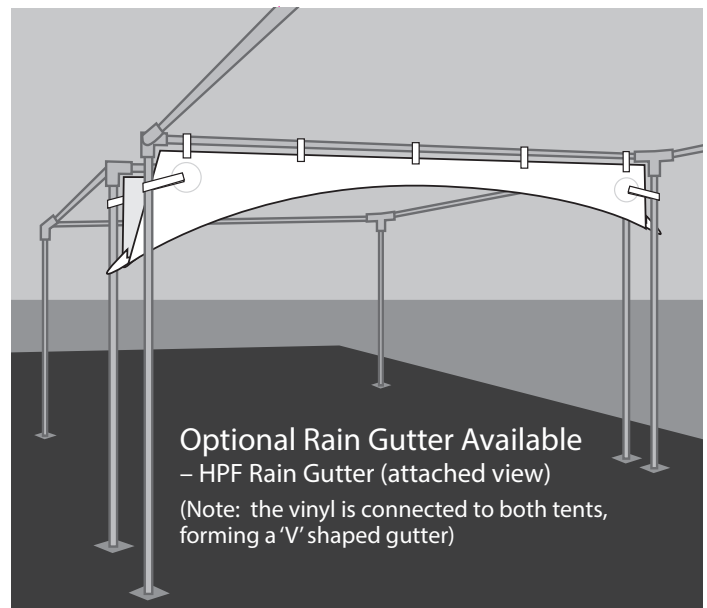
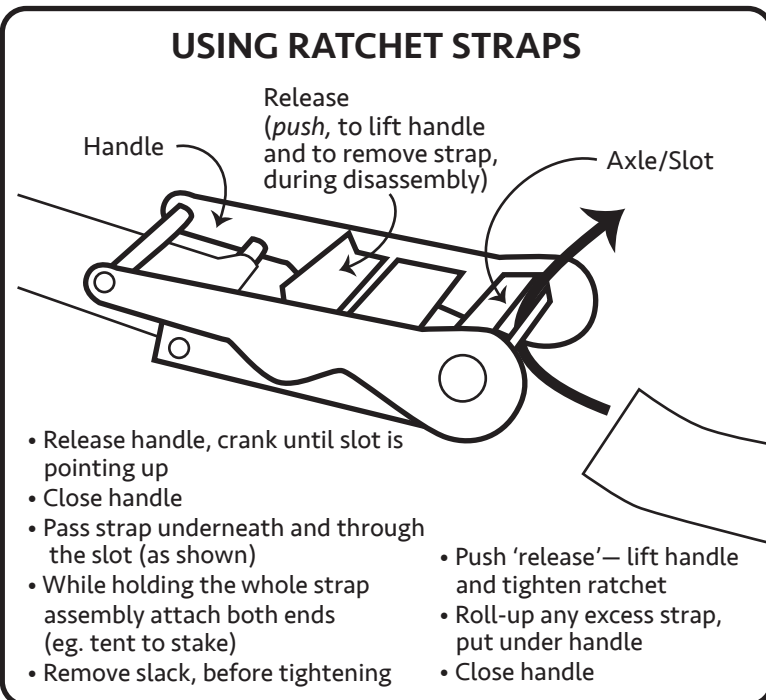

SKUs: BT-FH10RG (10'), BT-FH15RG (15'), BT-FH20RG (20'), BT-FH30RG (30'), BT-FH40RG (40')

Appendix A.

- Tent Plan— showing details (other available sizes below)

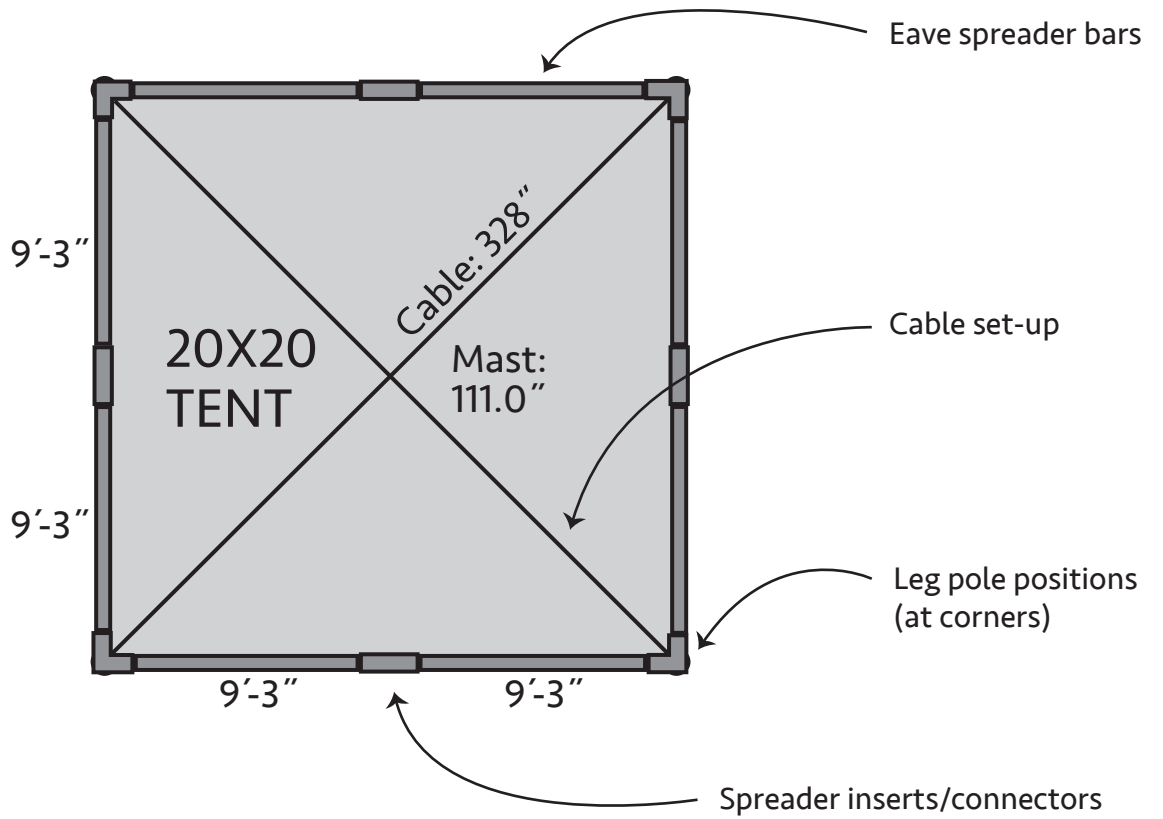

Other available sizes (High Peak Frame Tent)

